



**Quick Dental**  
International

# CATALOGUE



**SURGICAL**  
INSTRUMENTS

[WWW.QUICKDENTALINTL.COM](http://WWW.QUICKDENTALINTL.COM)



**Buck**

**QDI-1-101-18**

Percussion Hammer  
Polish Finish, Satin, 18.5 cm



**Buck**

**QDI-1-102-18**

20cm

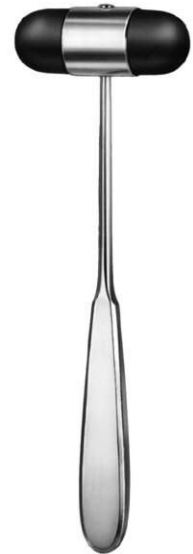

**Dejerine**

**QDI-1-103-20**

Percussion Hammer  
Finish, Satin, 20cm



**Dejerine**

**QDI-1-104-21**

Percussion Hammer  
Finish, Satin, 21cm



**Taylor Mod. USA**

**QDI-1-105-20**

Percussion Hammer  
Finish, Satin, 20cm



**Wartenberg**

**QDI-1-106-19**

Pinwheel  
Finish, Satin, 18 cm



**Pinard**  
**QDI-1-107-18**  
Stethoscope  
Finish, Satin, 18 cm



**Pinard**  
**QDI-1-108-15**  
Stethoscope  
Finish, Satin, 15cm



**Magill**

**QDI-2-101-15**

Catheter Introducing Forceps  
Finish, Satin, 14.5 cm , 20cm, 25 cm



**Miller**

**QDI-1-101-18**

Laryngoscope Sets  
Finish, Satin



**Millar-Baby**

**QDI-2-103-00**

Laryngoscope Sets  
Finish, Satin



**Miller**

**QDI-2-104-00**

Laryngoscope Blade  
Finish, Satin, Fig. 0, Fig. 1, Fig. 2, Fig. 3, Fig. 4



**Guedel-Negus**

**QDI-2-105-00**

Laryngoscope Sets  
Finish, Satin, Fig. 2, Fig. 3, Fig. 4



**Guedel-Negus**

**QDI-2-106-00**

Laryngoscope Sets  
Finish, Satin, Fig. 1, Fig. 2, Fig. 3, Fig. 4



**Guedel-Negus**  
**QDI-2-107-01**

Laryngoscope Blades  
Finish, Satin, Fig. 1, Fig. 2, Fig. 3, Fig. 4



**McIntosh**  
**QDI-2-108-00**  
McIntosh



**McIntosh**  
**QDI-2-109-00**  
Laryngoscope Blades  
Finish, Satin, Fig. 0, Fig. 1, Fig. 2, Fig. 3, Fig. 4



**McIntosh**  
**QDI-2-110-00**  
Laryngoscope Sets  
Finish, Satin, Fig. 1, Fig. 2, Fig. 3, Fig. 4



**Foregger**  
**QDI-2-111-01**  
Laryngoscope Blades  
Finish, Satin, Fig. 1, Fig. 2, Fig. 3, Fig. 4



**Battery Handle**  
**QDI-2-112-00**  
Battery Handle  
Finish, Satin



**McIntosh**

**QDI-2-114-00**

Laryngoscope Sets fiber optic  
Finish, Satin, Fig. 1, Fig. 2, Fig. 3



**McIntosh**

**QDI-2-115-00**

Laryngoscope Sets fiber optic  
Finish, Satin, Fig. 1, Fig. 2, Fig. 3



**McIntosh**

**QDI-2-116-00**

Laryngoscope Sets fiber optic  
Finish, Satin, Fig. 1, Fig. 2, Fig. 3



**McIntosh**

**QDI-2-113-00**

Laryngoscope Sets  
Finish, Satin, Fig. 1, Fig. 2, Fig. 3, Fig. 4



**Universal**  
**QDI-3-101-04**  
Trocar  
Finish, Satin, 14 cm



**Nelson**  
**QDI-3-102-07**  
Trocar  
Finish, Satin, 20cm



**Lichtwitz**  
**QDI-3-103-19**  
Antrum Trocar  
Finish, Satin, 18.5 cm



**Adson**  
**QDI-3-104-21**  
Suction Cannula  
Finish, Satin, 20cm



**Frazier**  
**QDI-3-105-10**  
Suction Cannula  
Finish, Satin, 24 cm



**Frazier**  
**QDI-3-106-06**  
Suction Cannula  
Finish, Satin, 19.5 cm



**Poppen**  
**QDI-3-107-06**  
Suction Cannula  
Finish, Satin, 18 cm



**Luer**  
**QDI-3-108-30**  
Suction Tube working length 110 mm  
Finish, Satin



**Yasargil**  
**QDI-3-109-15**  
Suction Tube working length 150 mm with Luer  
hub  
Finish, Satin



**Yankauer**  
**QDI-3-110-27**  
Suction Tube complete with suction tip and  
connector  
Finish, Satin, 31 cm



**Yankauer**  
**QDI-3-111-00**  
Suction Tube  
Finish, Satin, 31 cm , 15 cm, 2.5 cm, 10 cm



**Poole**  
**QDI-3-112-22**  
Suction Tube  
Finish, Satin, 22cm





**Poole**

**QDI-3-113-22**

Suction Tube

Finish, Satin, 22.5 cm



**Nuboer**

**QDI-3-114-21**

Suction Tube

Finish, Satin, 21cm



**Nuboer**

**QDI-3-115-21**

Suction Tube

Finish, Satin, 21cm



**Quinke**

**QDI-3-116-10**

Lumbar Puncture Needle

Finish, Satin



**Tuohy**

**QDI-3-117-12**

Lumbar Puncture Needle Luer Lock connection

with special tip  
Finish, Satin



**Verres**

**QDI-3-118-20**

Insufflation Cannula Luer Lock connection

Finish, Satin, 15 cm



**Verres**

**QDI-3-119-20**

Insufflation Cannula Luer Lock connection  
Finish, Satin, 17 cm



**Kalt**

**QDI-4-105-14**

Needle Holder  
Finish, Satin, 13.5 cm



**Barraquer-Troutman**

**QDI-4-106-10**

Micro Needle Holder  
Finish, Satin, 10 cm , 10.5 cm



**Arruga**

**QDI-4-107-14**

Micro Needle Holder  
Finish, Satin, 13.5 cm



**Barraquer-Troutman**

**QDI-4-108-10**

Micro Needle Holder  
Finish, Satin, 10.5 cm , 11.5cm



**Barraquer**

**QDI-4-109-11**

Micro Needle Holder  
Finish, Satin, 11.5cm, 13.5 cm , 14 cm



**Barraquer**

**QDI-4-110-13**

Micro Needle Holder  
Finish, Satin, 13.5 cm



**Castroviejo-Fino**  
**QDI-4-111-01**  
Micro Needle Holder  
Finish, Satin, 13cm



**Castroviejo-Fino**  
**QDI-4-112-01**  
Micro Needle Holder  
Finish, Satin, 13cm



**Castroviejo-Fino**  
**QDI-4-113-01**  
very delicate jaw with lock  
Finish, Satin, 13cm



**Castroviejo**  
**QDI-4-114-14**  
Micro Needle Holder with lock  
Fig.65, Fig.69, Fig.88 L, Finish, Satin, 14 cm



**Castroviejo**  
**QDI-4-115-14**  
Micro Needle Holder  
Finish, Satin, 14 cm



**Castroviejo**  
**QDI-4-121-14**  
Micro Needle Holder with lock  
Finish, Satin, 14 cm



**Castroviejo**  
**QDI-4-122-14**

Micro Needle Holder  
Finish, Satin, 14 cm



**Castroviejo**  
**QDI-4-124-13**

Micro Needle Holder with lock  
Finish, Satin

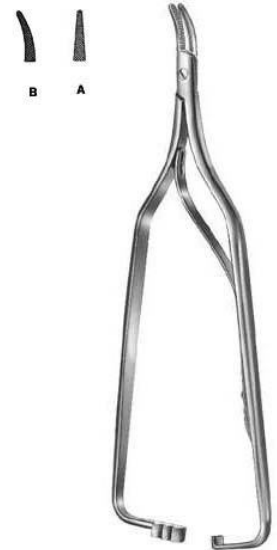

**Arruga**

**QDI-4-123-16**

Needle Holder delicate  
Finish, Satin, 16 cm



**Castroviejo**  
**QDI-4-125-12**

Micro Needle Holder with lock  
12 cm



**Derf**

**QDI-4-126-12**

Needle Holder  
Finish, Satin, 12 cm, 13cm

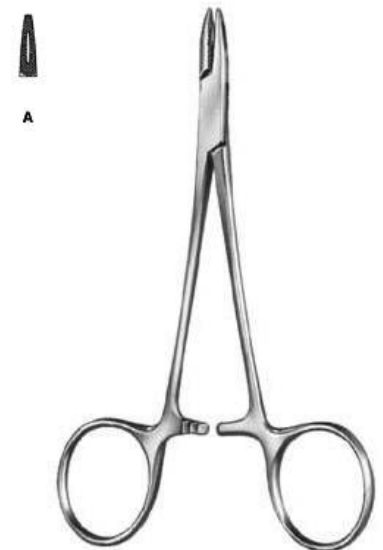

**Collier**

**QDI-4-127-12**

Needle Holder  
Finish, Satin, 12.5 cm



**Webster**  
**QDI-4-128-13**  
Needle Holder  
Finish, Satin, 13cm



**Halsey**  
**QDI-4-129-13**  
Needle Holder  
Finish, Satin, 13.5 cm

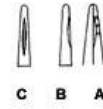

**Neivert**  
**QDI-4-130-13**  
Neivert  
Finish, Satin, 12.5 cm



**Metzenbaum**  
**QDI-4-141-18**  
Needle Holder one grooved and fenestrated jaw  
Finish, Satin, 18.5 cm



**M. G. Hospital**  
**QDI-4-142-17**  
Needle Holder  
Finish, Satin, 17.5 cm



**Mayo-Hegar**  
**QDI-4-143-14**  
Needle Holder  
Finish, Satin, 14.5 cm , 16 cm , 18.5 cm , 24 cm



**Adson**

**QDI-4-140-18**

Needle Holder one fenestrated jaw  
Finish, Satin, 18 cm



**Metzenbaum**

**QDI-4-141-18**

Needle Holder one grooved and fenestrated jaw  
Finish, Satin, 18.5 cm



**M. G. Hospital**

**QDI-4-142-17**

Needle Holder  
Finish, Satin, 17.5 cm

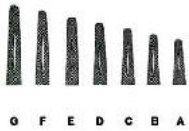

**Mayo-Hegar**

**QDI-4-143-14**

Needle Holder  
Finish, Satin, 14.5 cm , 16 cm , 18.5 cm , 20.5 cm,  
24 cm , 26.5 cm

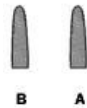

**Brown**

**QDI-4-145-13**

Needle Holder  
Finish, Satin, 13cm, 18 cm



**Mayo Hegar**

**QDI-4-144-16**

Needle Holder  
Finish, Satin, 16 cm , 18.5 cm , 20.5 cm

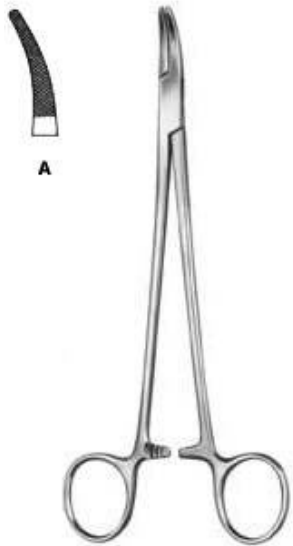

**Heaney**  
QDI-4-146-21  
Needle Holder  
Finish, Satin, 20.5 cm

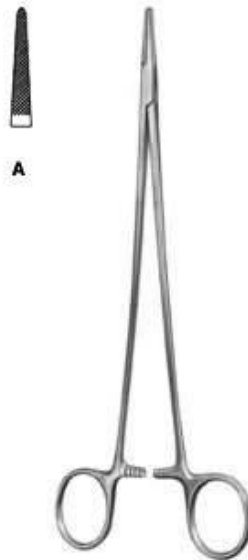

**Jamison**  
QDI-4-147-23  
Needle Holder  
Finish, Satin, 23.5 cm



**Masson**  
QDI-4-148-27  
Needle Holder  
Finish, Satin, 26.5 cm

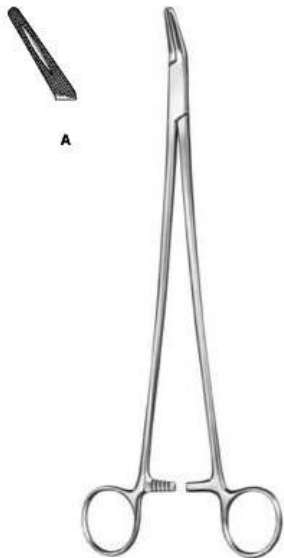

**Finochietto**  
QDI-4-149-27  
Needle Holder  
Finish, Satin, 26.5 cm



**Wangenstein**  
QDI-4-150-27  
Needle Holder  
Finish, Satin, 26.5 cm

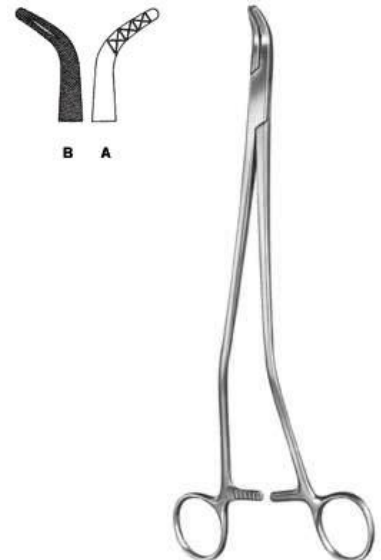

**Johnson**  
QDI-4-151-27  
Needle Holder  
Finish, Satin, 27 cm



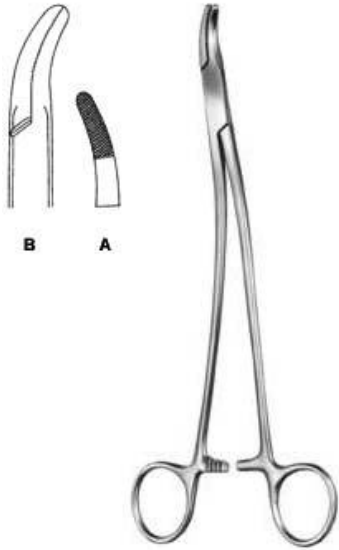

**Stratte**  
QDI-4-152-23  
Needle Holder  
Finish, Satin, 23 cm

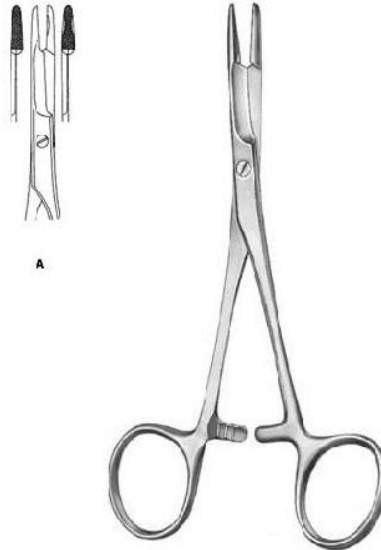

**Olsen-Hegar**  
QDI-4-153-14  
Needle Holder  
Finish, Satin, 14 cm

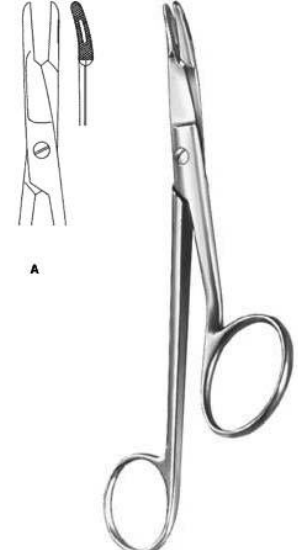

**Gillies**  
QDI-4-154-16  
Needle Holder  
Finish, Satin, 16 cm



**Crile**  
QDI-155-15  
Needle Holder  
Finish, Satin, 15 cm



**Mathieu**  
QDI-4-156-14  
Needle Holder  
Finish, Satin, 14 cm, 17 cm, 20cm



**Mathieu**  
QDI-4-157-14  
Needle Holder  
Finish, Satin, 16.5 cm



**Toennis**

**QDI-4-158-18**

Needle Holder

Finish, Satin, 18.5 cm



**Lichtenberg**

**QDI-4-159-20**

Needle Holder

Finish, Satin, 20cm

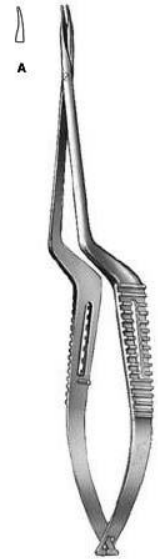

**Micro Needle Holder**

**QDI-4-160-16**

Micro Needle Holder

Finish, Satin, 16 cm

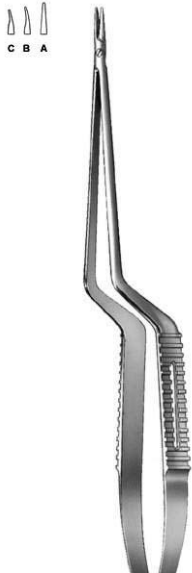

**Micro Needle Holder**

**QDI-4-161**

Micro Needle Holder

Finish, Satin, 19 cm



**Hepp-Scheidel**

**QDI-4-162-18**

Micro Needle Holder smooth jaw

Finish, Satin, 18 cm



**Webster**

**QDI-4-163-13**

Needle Holder with automatic release ratchet  
also for lefthanders

Fig.233, 16 cm , 12 cm, Finish, Satin, 13cm, 15 cm



**Micro Needle Holder**

**QDI-4-164-15**

Micro Needle Holder  
Finish, Satin, 15 cm, 18 cm, 21cm, 23 cm



**JABOMA**

**QDI-4-165-18**

Micro Needle Holder  
Finish, Satin, 18 cm



**Castroviejo**

**QDI-4-166**

Micro Needle Holder  
Fig.233, 16 cm , 12 cm, Fig.18 L, Finish, Satin, 14.5 cm , 18 cm, 21cm



**Arruga**

**QDI-4-167**

Needle Holder  
Fig.233, 16 cm , 12 cm, Fig.18 L, Finish, Satin, 16 cm



**Castroviejo**

**QDI-4-168-13**

Micro Needle Holder  
Finish, Satin, 12.5 cm



**Barraquer**

**QDI-4-169-13**

13 cm , Finish, Satin



**Barraquer**  
**QDI-4-170-13**  
Micro Needle Holder  
13 cm , Finish, Satin



**Webster**  
**QDI-4-171-13**  
Needle Holder  
13 cm , Finish, Satin



**Derf**  
**QDI-4-173-12**  
Needle Holder  
12 cm, Finish, Satin

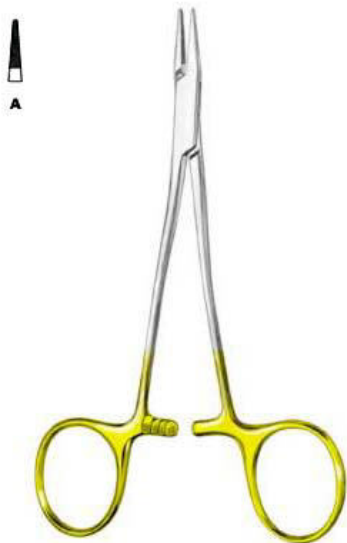

**Kilner**  
**QDI-4-172-13**  
13 cm , Finish, Satin



**Hegar-Baumgartner**  
**QDI-4-174-13**  
Needle Holder  
13 cm , 14.5 cm , Finish, Satin



**Halsey**  
**QDI-4-175-12**  
Needle Holder  
13 cm , 12 cm, Finish, Satin



**Crile-Wood**  
**QDI-4-176-15**  
Needle Holder  
15 cm, Finish, Satin



**Sarot**  
**QDI-4-177-18**  
Needle Holder  
18 cm, 20 cm, 26 cm, Finish, Satin

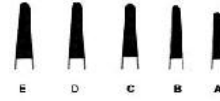

**Mayo-Hegar**  
**QDI-4-178-16**  
Needle Holder standard profile  
16 cm, 18 cm, 20 cm, 24 cm, 26 cm, 30 cm,  
Finish, Satin



**Heaney**  
**QDI-4-179-20**  
Needle Holder  
20 cm, 24 cm, 26 cm, Finish, Satin

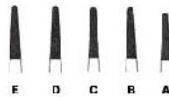

**DeBakey**  
**QDI-4-180-18**  
Needle Holder delicate pattern mini profile  
18 cm, 20 cm, 23 cm, 26 cm, 31 cm, Finish, Satin



**Masson**  
**QDI-4-181-27**  
Needle Holder  
26.5 cm, Finish, Satin

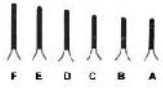

**Ryder (Martin)**

**QDI-4-182-13**

Needle Holder

12.5 cm, 15 cm, 18 cm, 20 cm, 23 cm, 26 cm,  
Finish, Satin



**Martin**

**QDI-4-183-15**

Needle Holder mini profile elastic type

15 cm, 17 cm, 20 cm, Finish, Satin



**Wangensteen**

**QDI-4-184-27**

Needle Holder standard profile

27 cm, Finish, Satin



**Hegar-Vascular**

**QDI-4-185-14**

Needle Holder micro profile

14 cm, 18.5 cm, 20.5 cm, 23 cm, Finish, Satin

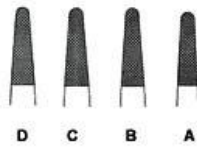

**Bozemann**

**QDI-4-186-20**

Needle Holder standard profile

20.5 cm, 24 cm, 26.5 cm, 29 cm, Finish, Satin



**Hegar**

**QDI-4-187-20**

Needle Holder standard profile

20 cm, 23.5 cm, Finish, Satin



**Stratte**

**QDI-4-188-22**

Needle Holder standard profile  
23 cm, Finish, Satin

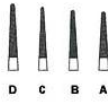

**Microvascular**

**QDI-4-189-00**

Needle Holder slender pattern micro profile  
14 cm, 17.5 cm, 20 cm, 23 cm, Finish, Satin



**Mathieu**

**QDI-4-190-14**

Needle Holder  
14 cm, 17 cm, 20 cm, Finish, Satin



**Mathieu**

**QDI-4-191-14**

Needle Holder  
14 cm, 17 cm, 20 cm, Finish, Satin

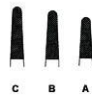

**Mathieu**

**QDI-4-192-17**

Needle Holder standard profile with interior  
ratchet  
17 cm, 20 cm, 23 cm, Finish, Satin



**Toennis**

**QDI-4-193-18**

Needle Holder  
18.5 cm, Finish, Satin



**Lichtenberg**  
**QDI-4-194-20**

Needle Holder lightweight model standard profile  
20 cm, Finish, Satin



**Langenbeck**  
**QDI-4-195-18**

Needle Holder  
18 cm, 20.5 cm, 23 cm, Finish, Satin



**Zweifel**  
**QDI-4-196-20**

Needle Holder with hinged ratchet standard profile  
20.5 cm, 23 cm, Finish, Satin



**Reverdin**  
**QDI-4-197-15**

Reverdin Needle short  
14 cm Fig. 1, 14 cm Fig. 2, 14 cm Fig. 3, 14 cm Fig. 4, Finish, Satin

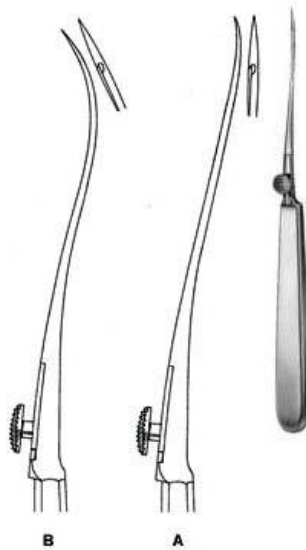

**Reverdin**  
**QDI-4-198-19**

Reverdin Needle medium  
19.5 cm Fig. 1, 19.5 cm Fig. 2, 19.5 cm Fig. 3, 19.5 cm Fig. 4, Finish, Satin

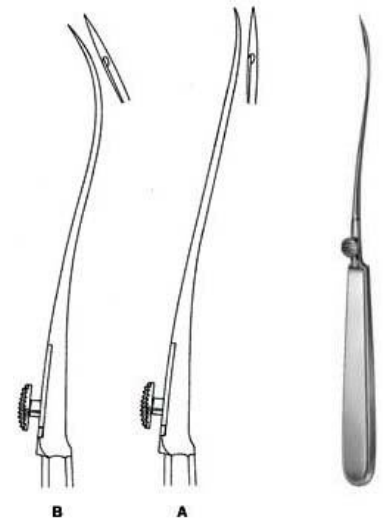

**Reverdin**  
**QDI-4-199-23**

Reverdin Needle long  
23 cm Fig. 1, 23 cm Fig. 2, 23 cm Fig. 3, 23 cm Fig. 4, Finish, Satin



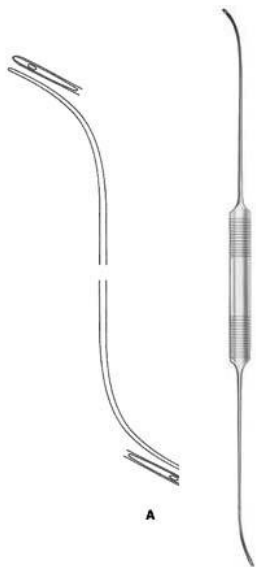

**Schmieden-Dick**  
**QDI-4-201-01**  
Ligature Needle malleable  
29 cm, Finish, Satin

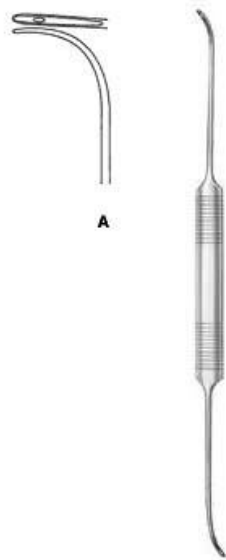

**Schmieden**  
**QDI-4-202-21**  
Ligature Needle  
24 cm, Finish, Satin



**Ligature Needle Malleable**  
**QDI-4-203-20**  
Ligature Needle malleable  
20.5 cm, Finish, Satin

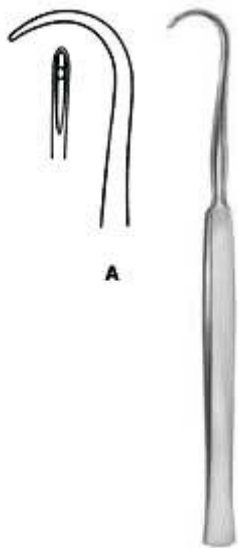

**Cooper**  
**QDI-4-204-19**  
Ligature Needle  
18.5 cm, Finish, Satin



**Kronecker**  
**QDI-4-205-13**  
Ligature Needle delicate for right hand  
12.5 cm, Finish, Satin

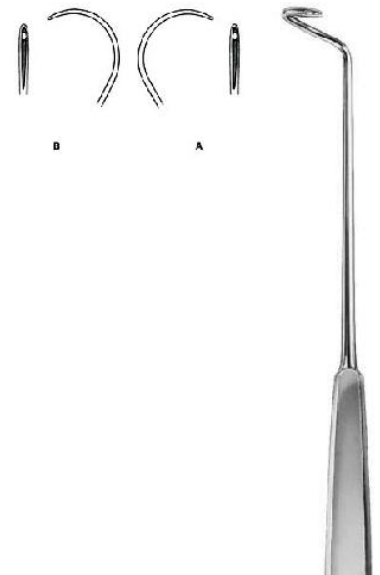

**Deschamps**  
**QDI-4-206-24**  
Ligature Needle  
24 cm, Finish, Satin

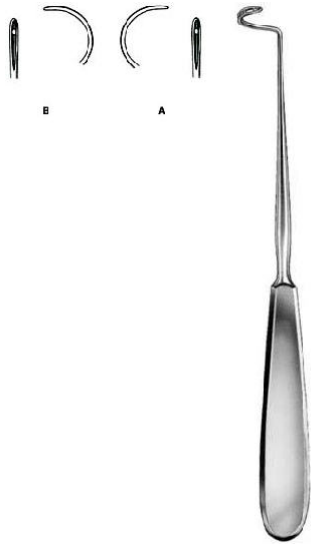

**Deschamps**  
**QDI-4-207-20**

Ligature Needle blunt for right hand  
20 cm, Finish, Satin



**Deschamps**  
**QDI-4-208-20**

Ligature Needle sharp for right hand  
20 cm, Finish, Satin

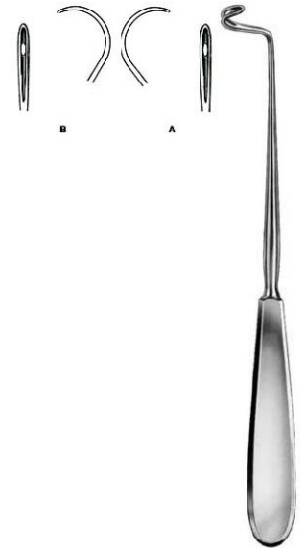

**Deschamps**  
**QDI-4-209-21**

Ligature Needle blunt for right hand  
20 cm, Finish, Satin

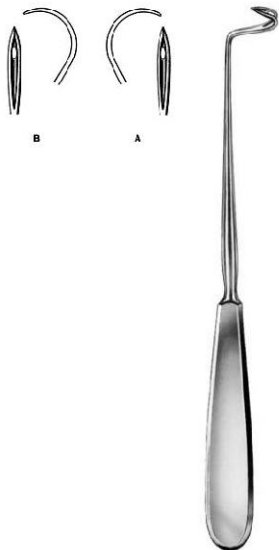

**Deschamps**  
**QDI-4-210-21**

Ligature Needle sharp for right hand  
20 cm, Finish, Satin

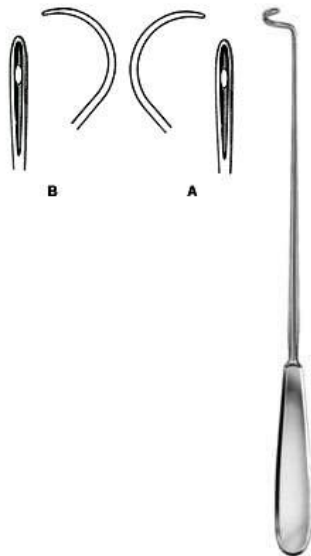

**Deschamps**  
**QDI-4-211-27**

Ligature Needle blunt for right hand  
27 cm, Finish, Satin

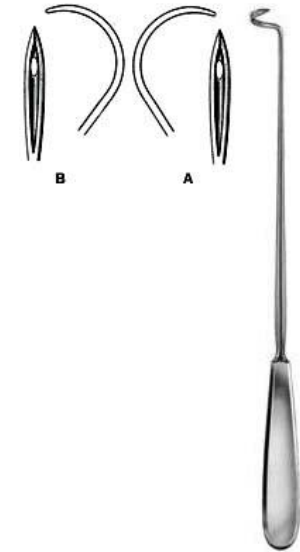

**Deschamps**  
**QDI-4-212-27**

Ligature Needle sharp for right hand  
27 cm, Finish, Satin

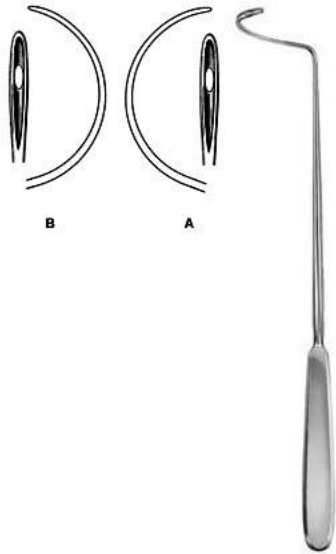

**Deschamps**  
**QDI-4-213-28**

28 cm, Finish, Satin

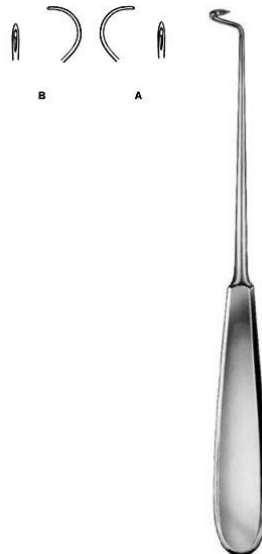

**Deschamps**  
**QDI-4-214-20**

Ligature Needle sharp for right hand  
20 cm, Finish, Satin



**Deschamps**  
**QDI-4-215-20**

Ligature Needle blunt for right hand  
20 cm, Finish, Satin



**Deschamps**  
**QDI-4-216-20**

Ligature Needle blunt for right hand  
21 cm, Finish, Satin

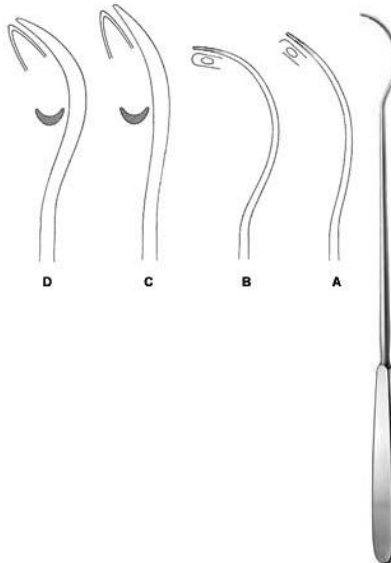

**Brunner**

**QDI-4-217-30**  
Ligature Needle  
21 cm, Finish, Satin



**Kirschner**

**QDI-4-218-25**  
Ligature Conductor  
25.5 cm, Finish, Satin

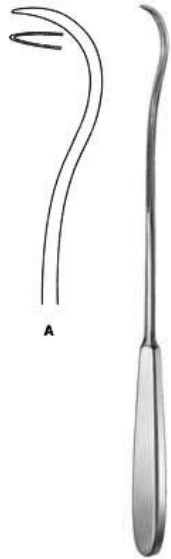

**Ligature Conductor**

**QDI-4-219-28**

Ligature Conductor  
28 cm, Finish, Satin



**Modell Wien**

**QDI-4-220-23**

Ligature Catcher  
23.5 cm , Finish, Satin



**Michel**

**QDI-4-221-12**

Clip Applying Forceps  
12 cm, Finish, Satin



**Hegenbarth**

**QDI-4-222-12**

Clip Applying Forceps  
12 cm, Finish, Satin



**Dissecting Knife**

**QDI-5-101-01**

Dissecting Knife with metal handle  
Finish, Finish, 15 cm, 15.5 cm, 16 cm , 17 cm



**Autopsy Knife**

**QDI-5-102-10**

Autopsy Knife  
Finish, Satin, 25.5 cm

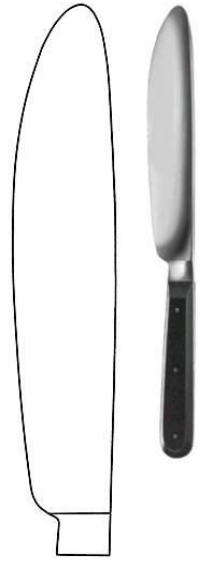

**Walb**

**QDI-5-104-17**

Post Mortem Knife

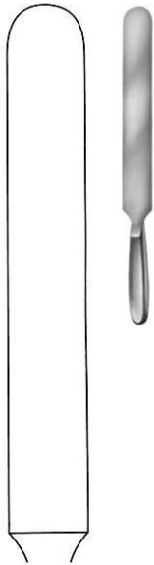

**Virchow**

**QDI-5-105-20**

Virchow  
Finish, Satin, 28.5 cm, 33.5 cm, 38 cm



**Scalpel Handle**

**QDI-5-108-04**

Scalpel Handle  
13.5 cm , Finish, Satin



**Scalpel Handle**

**QDI-5-109-34**

Scalpel Handle  
Finish, Satin, 16 cm



**Scalpel Handle**  
**QDI-5-110-41**  
Scalpel Handle  
Finish, Satin, 21cm



**Scalpel Handle**  
**QDI-5-111-45**  
Scalpel Handle  
Finish, Satin, 21cm



**Collin**  
**QDI-5-112-08**  
Scalpel Handle with hollow handle  
Finish, Satin, 13.5 cm



**Collin**  
**QDI-5-113-09**  
Scalpel Handle with hollow handle  
14.5 cm , Finish, Satin



**Scalpel Handle**  
**QDI-5-114-03**  
Scalpel Handle  
Finish, Satin, 12 cm



**Scalpel Handle**  
**QDI-5-115-04**  
Scalpel Handle  
12 cm, Finish, Satin



**Scalpel Handle**  
**QDI-5-116-05**  
Scalpel Handle  
12 cm, Finish, Satin



**Scalpel Handle**  
**QDI-5-117-31**  
Scalpel Handle  
21.5 cm, Finish, Satin



**Scalpel Handle**  
**QDI-5-118-35**  
Scalpel Handle  
21cm, Finish, Satin



**Scalpel Handle**  
**QDI-5-119-07**  
Scalpel Handle  
16 cm, Finish, Satin



**Scalpel Handle**  
**QDI-5-120-71**  
Scalpel Handle  
12.5 cm, Finish, Satin



**Scalpel Handle**  
**QDI-5-121-03**  
Scalpel Handle  
15.5 cm, Finish, Satin



**Amputation Knife**

**QDI-5-127-16**

Amputation Knife  
29 cm, Finish, Satin



**Amputation Knife**

**QDI-5-128-19**

Amputation Knife  
32.5 cm, Finish, Satin



**Catlin**

**QDI-5-129-16**

Interosseous Knife with hollow handle  
29 cm, Finish, Satin



**Resection Knife**

**QDI-5-130-06**

Resection Knife  
18 cm, Finish, Satin



**Langenbeck**

**QDI-5-131-05**

Resection Knife  
18 cm, Finish, Satin



**Langenbeck**

**QDI-5-132-05**

Langenbeck  
18 cm, Finish, Satin





**Razor Knife**  
**QDI-5-133-00**

Razor Knife hollow blades on both sides cutting length 75mm  
Finish, Satin



**Schink**

**QDI-5-134-00**

Dermatome complete with 2 skin fixing plates and one blade  
31 cm , Finish, Satin

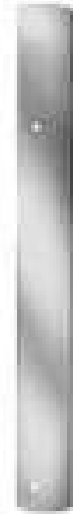

**Schink**

**QDI-5-135-01**

Spare Blade spare blade for KE-05-134-00  
Finish, Satin



**Schink**

**QDI-5-136-02**

Skin Fixing Plate for KE-05-134-00  
Finish, Satin



**Standard BL / BL Straight**

**QDI-5-201-13**

Operating Scissor Special Price: \$1.25  
12 cm, 13cm, 14.5 cm , 16.5 cm , 18.5 cm , 20.5  
cm, Polish Finish, Satin



**Standard SH / BL STR**

**QDI-5-202-13**

Operating Scissors  
12 cm, 13cm, 14.5 cm , 16.5 cm , 18.5 cm , 20.5  
cm, Polish Finish, Satin



**Standard SH / SH STR**

**QDI-5-204-13**

Operating Scissors  
12 cm, 13cm, 14.5 cm , 16.5 cm, Polish Finish,  
Satin



**Standard BL / BL Curved**

**QDI-5-205-13**

Operating Scissors  
12 cm, 13cm, 14.5 cm , 16.5 cm , 18.5 cm , 20.5  
cm, Polish Finish, Satin



**Standard SH / BL Curved**

**QDI-5-206-13**

Operating Scissors  
12 cm, 13cm, 14.5 cm , 16.5 cm , 18.5 cm , 20.5  
cm, Polish Finish, Satin



**Standard SH / SH Curved**

**QDI-5-207-13**

Operating Scissors  
12 cm, 13cm, 14.5 cm , 16.5 cm, Polish Finish,  
Satin



**Standard BL / BL Curved**

**QDI-5-208-14**

Operating Scissors delicate  
Polish Finish, Satin, 14.5 cm



**Incision Scissor**

**QDI-5-209-14**

Operating Scissor  
14.5 cm , Polish Finish, Satin



**Deaver**

**QDI-5-210-14**

Operating Scissors



**Mayo**

**QDI-5-211-15**

Dissecting Scissors  
14.5 cm , 15 cm, 17 cm , 23.5 cm , Polish Finish,  
Satin



**Mayo**

**QDI-5-212-23**

Dissecting Scissors  
23 cm , 22.5 cm, 28 cm, Polish Finish, Satin



**Mayo-Harrington**

**QDI-5-213-22**

Dissecting Scissors  
23 cm , 22.5 cm, 28 cm, Polish Finish, Satin

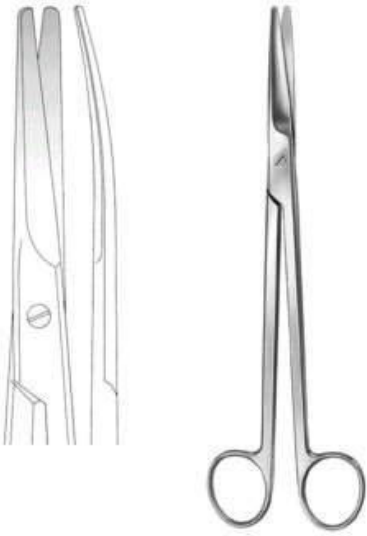

**Mayo-Harrington**

**QDI-5-214-22**

Dissecting Scissors cur.  
22.5 cm, 23 cm , 28 cm, Polish Finish, Satin

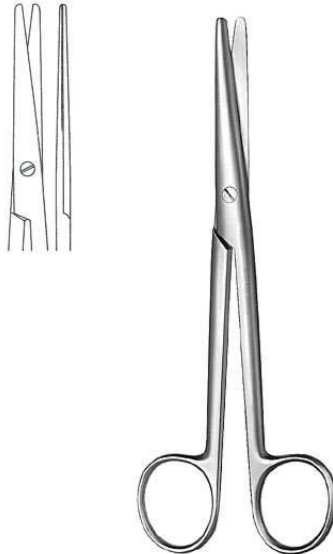

**Mayo-Stille**

**QDI-5-215-17**

Dissecting Scissors str.  
15 cm, 17 cm , Polish Finish, Satin

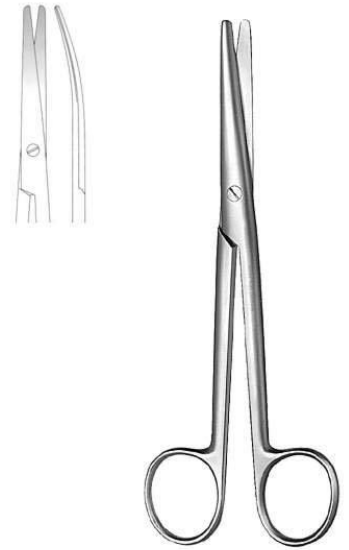

**Mayo-Stille**

**QDI-5-216-15**

Dissecting Scissors cur.  
15 cm, 17 cm , Polish Finish, Polish Finish

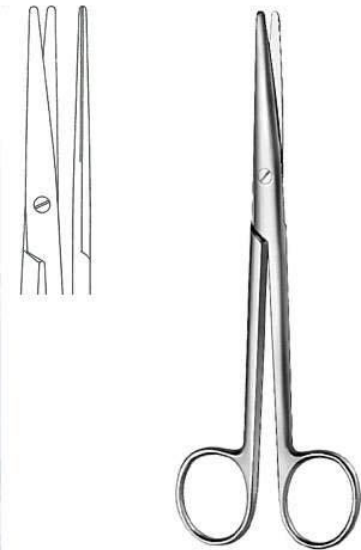

**Mayo-Stille**

**QDI-5-217-19**

16 cm, 19.5 cm , 21.5 cm, Polish Finish, Satin

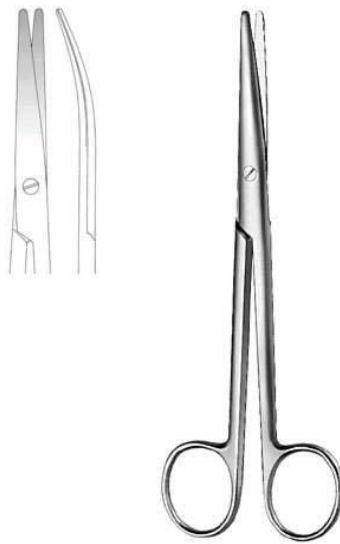

**Mayo-Stille**

**QDI-5-218-16**

Dissecting Scissors cur.  
16 cm, 19.5 cm , 21.5 cm, Polish Finish, Satin



**Mayo-Noble**

**QDI-5-219-17**

Gynecological Scissors  
16.5 cm, Polish Finish, Satin

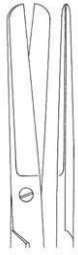

**Sims**

**QDI-5-220-23**

Gynecological Scissors str.  
20cm, 23 cm , Polish Finish, Satin



**Sims**

**QDI-5-221-20**

Gynecological Scissors cur.  
20cm, 23 cm , Polish Finish, Satin



**Kelly**

**QDI-5-222-16**

Operating Scissors  
16 cm, Finish, Satin



**Doyen**

**QDI-5-223-17**

Gynecological Scissors  
18.5 cm , Polish Finish, Satin



**Sims-Siebold**

**QDI-5-224-24**

24.5 cm, Finish, Satin



**Sims-Siebold**

**QDI-5-225-24**

Gynecological Scissors  
24.5 cm, Finish, Satin



**Wertheim**

**QDI-5-226-23**

Gynecological Scissors  
20cm, 23 cm , Finish, Satin



**Metzenbaum**

**QDI-5-227-11**

Dissecting Scissors  
11, Finish, Satin



**Metzenbaum**

**QDI-5-228-14**

Dissecting Scissors  
14.5 cm , Finish, Satin



**Metzenbaum**

**QDI-5-229-15**

Dissecting Scissors  
15.5 cm, Finish, Satin



**Metzenbaum-Nelson**

**QDI-5-230-20**

Dissecting Scissors  
18 cm, 20.5 cm, 23 cm , 26 cm, 28.5 cm, 31 cm ,  
Finish, Satin



**Metzenbaum-Nelson**

**QDI-5-231-20**

Dissecting Scissors  
18 cm, 20.5 cm, Finish, Satin



**Metzenbaum-Nelson**

**QDI-5-232-20**

Dissecting Scissors

18 cm, 20.5 cm, 23 cm, 26 cm, 28.5 cm, 31 cm,  
Finish, Satin



**Metzenbaum**

**QDI-5-233-14**

Dissecting Scissors toothed

14.5 cm, Finish, Satin



**Nerve Operating Scissor**

**QDI-5-234-15**

Dissecting Scissors

15.5 cm, Finish, Satin

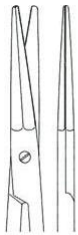

**Gorney**

**QDI-5-235-19**

Face-lift Scissors str.

12.5 cm, 19.5 cm, Finish, Satin



**Gorney**

**QDI-5-236-19**

Face-lift Scissors cur.

19.5 cm, Finish, Satin



**Aston**

**QDI-5-237-17**

Face-lift Scissors

17 cm, Finish, Satin



**Lexer**

**QDI-5-238-16**

Dissecting Scissors  
16 cm, Finish, Satin

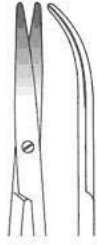

**Cinelli**

**QDI-5-239-14**

Nasal Scissors  
11.5cm, 14 cm, Finish, Satin



**Thorek**

**QDI-5-240-19**

Dissecting Scissors  
18.5 cm, Finish, Satin



**Lexer-Baby**

**QDI-5-241-10**

Dissecting Scissors  
10 cm, Finish, Satin



**Lexer-Fino**

**QDI-5-242-16**

Delicate Dissecting Scissors slender pattern  
16.5 cm, Finish, Satin



**Metzenbaum-Fino**

**QDI-5-243-14**

Delicate Dissecting Scissors slender pattern  
14.5 cm, Finish, Satin





**Metzenbaum-Fino**

**QDI-5-244-14**

Delicate Dissecting Scissors  
14.5 cm , Finish, Satin



**Metzenbaum-Fino**

**QDI-5-245-14**

Delicate Dissecting Scissors  
14.5 cm , Finish, Satin



**Metzenbaum-Fino**

**QDI-5-246-14**

Delicate Dissecting Scissors  
14.5 cm , Finish, Satin

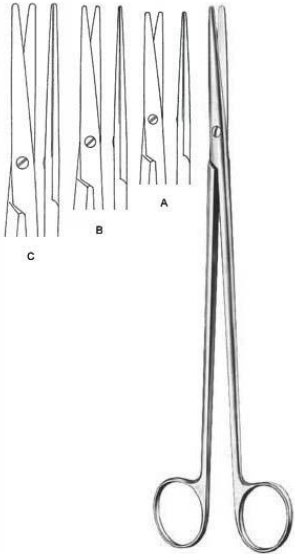

**Metzenbaum-Fino**

**QDI-5-247-18**

Delicate Dissecting Scissors slender pattern  
18 cm, 20cm, 23 cm , Finish, Satin

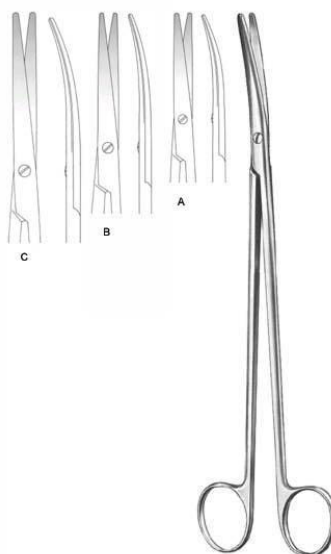

**Metzenbaum-Fino**

**QDI-5-248-18**

Delicate Dissecting Scissors slender pattern  
18 cm, 20cm, 23 cm , Finish, Satin

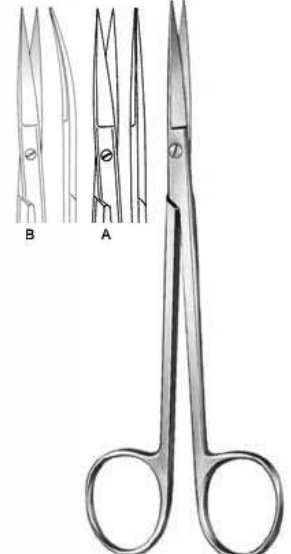

**Sanvenero**

**QDI-5-250-14**

Operating Scissors  
14 cm, Finish, Satin

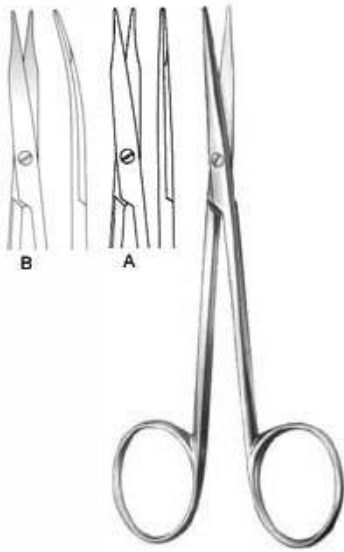

**Fine Operating Scissors**

**QDI-5-251-11**

Fine Operating Scissors  
11.5cm, Finish, Satin

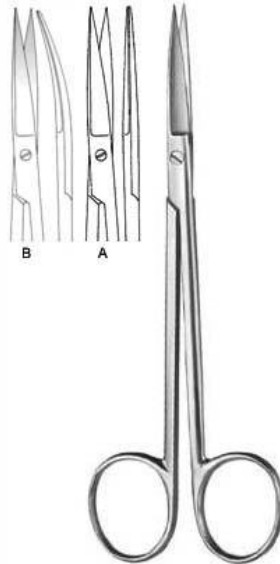

**Joseph**

**QDI-5-252-14**

Operating Scissors  
14.5 cm , Finish, Satin

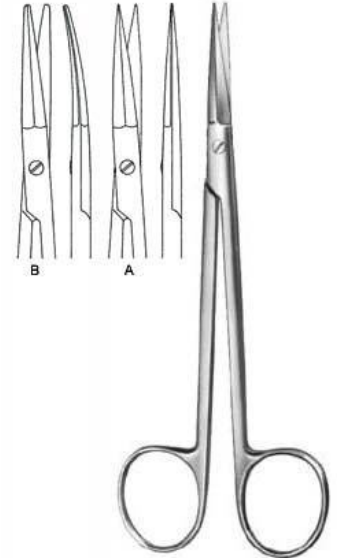

**Peck-Joseph**

**QDI-5-253-14**

Face-lift Scissors  
14.5 cm , Finish, Satin

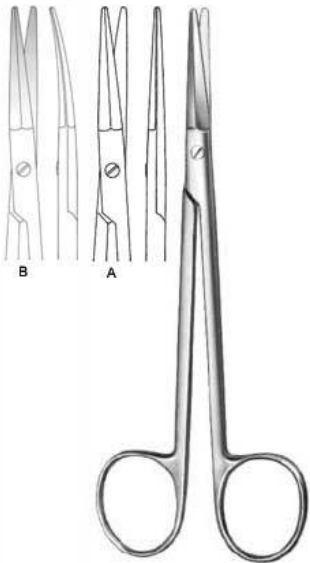

**Peck-Joseph**

**QDI-5-254-14**

Face-lift Scissors  
14.5 cm , Finish, Satin



**Shea Vein Graft**

**QDI-5-255-12**

Dissecting Scissors  
12 cm, Finish, Satin

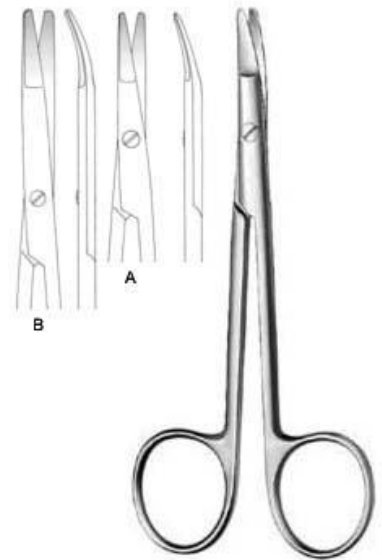

**Kilner**

**QDI-5-256-12**

Dissecting Scissors  
12 cm, 15 cm, Finish, Satin

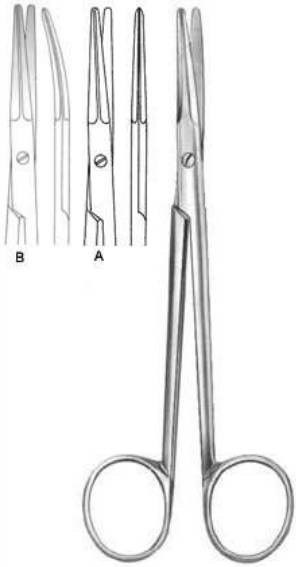

**Dissecting Scissors**

**QDI-5-257-14**

Dissecting Scissors  
14.5 cm , Finish, Satin

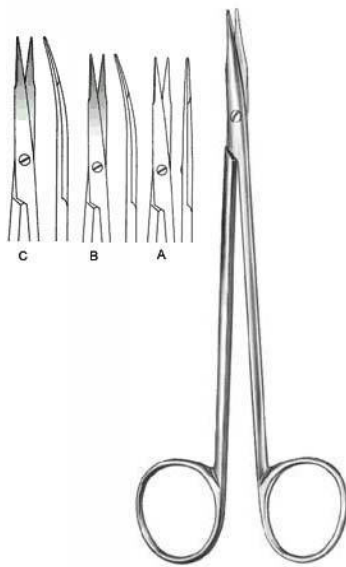

**Reynolds**

**QDI-5-258-15**

Dissecting Scissors  
15.5 cm, 18 cm, Finish, Satin



**Jameson**

**QDI-5-259-14**

Dissecting Scissors  
15.5 cm, Finish, Satin



**Jameson**

**QDI-5-260-14**

Dissecting Scissors  
15.5 cm, Finish, Satin



**Vascular Scissors**

**QDI-5-261-19**

Vascular Scissors  
19 cm , Finish, Satin

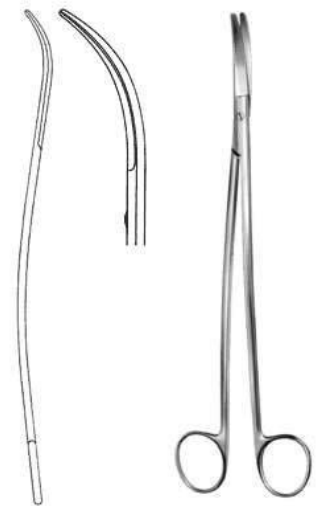

**Vascular Scissors**

**QDI-5-262-24**

Vascular Scissors  
19 cm , 25.5 cm, Finish, Satin

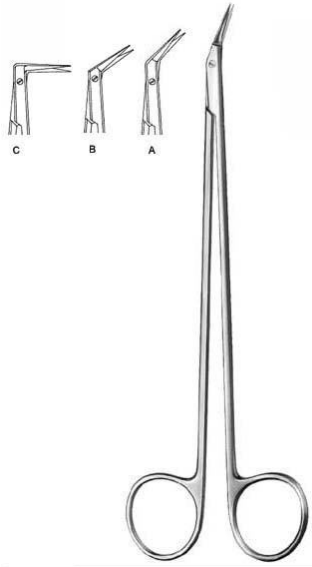

**Diethrich**

**QDI-5-263-25**

Vascular Scissors

17.5 cm, 18.5 cm, 19 cm, Finish, Satin

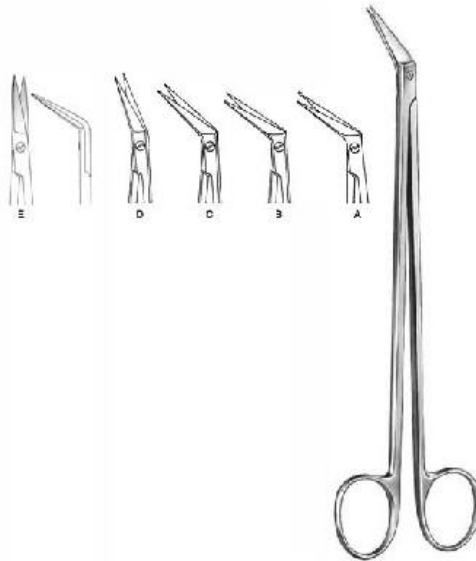

**DeBakey**

**QDI-5-264-45**

Vascular Scissors

16 cm, 16.5 cm, Finish, Satin

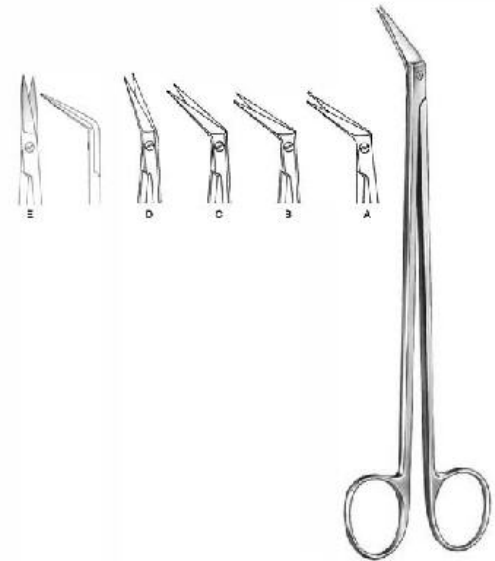

**Potts-Smith**

**QDI-5-265-19**

Vascular Scissors

18 cm, 18.5 cm, 19 cm, Finish, Satin



**Coronary Scissors**

**QDI-5-267-45**

Cardiovascular Surgery Scissors

18 cm, Finish, Satin



**Coronary Scissors**

**QDI-5-267-45**

Cardiovascular Surgery Scissors

18 cm, Finish, Satin



**Coronary Scissors**

**QDI-5-268-60**

Cardiovascular Surgery Scissor

18 cm, Finish, Satin



**Coronary Scissors**

**QDI-5-269-90**

Cardiovascular Surgery Scissor  
18 cm, Finish, Satin



**Coronary Scissors**

**QDI-5-270-00**

Cardiovascular Surgery Scissor  
18 cm, Finish, Satin



**Coronary Scissors**

**QDI-5-271-00**

Cardiovascular Surgery Scissor  
18 cm, Finish, Satin



**Coronary Scissors**

**QDI-5-272-25**

Cardiovascular Surgery Scissor  
18 cm, Finish, Satin



**Coronary Scissors**

**QDI-5-273-45**

Cardiovascular Surgery Scissor  
18 cm, Finish, Satin



**Coronary Scissors**

**QDI-5-274-90**

Cardiovascular Surgery Scissor  
18 cm, Polish Finish, Satin



**Schmieden-Taylor**

**QDI-5-275-17**

Dura Scissors  
15 cm, Finish, Satin



**Strully**

**QDI-5-276-22**

Neurosurgical Scissors  
22.5 cm, Finish, Satin



**Toennis-Adson**

**QDI-5-277-17**

Dissecting Scissors  
17.5 cm, Finish, Satin



**Good**

**QDI-5-279-19**

Tonsil Scissors  
19.5 cm, Finish, Satin



**Fomon**

**QDI-5-282-15**

Nasal Scissors  
15 cm, Finish, Satin



**Cottle**

**QDI-5-283-16**

Nasal Scissors  
16 cm, Finish, Satin



**Heymann**  
**QDI-5-284-18**  
Nasal Scissors  
18.5 cm , Finish, Satin



**Heymann**  
**QDI-5-285-18**  
Nasal Scissors  
18.5 cm , Finish, Satin



**Converse**  
**QDI-5-286-11**  
Nasal Scissors blunt & sharp  
10.5 cm , Finish, Satin



**Waldmann**  
**QDI-5-287-18**  
Episiotomy Scissors  
18 cm , Finish, Satin



**Braun-Stadler**  
**QDI-5-268-60**  
Episiotomy Scissors  
14.5 cm , Finish, Satin



**Braun-Stadler**  
**QDI-5-289-22**  
Episiotomy Scissors  
22cm, Finish, Satin



**Modell USA**

**QDI-5-290-10**

Umbilical Scissors  
10.5 cm , Finish, Satin



**Busch**

**QDI-5-292-16**

Umbilical Scissors  
16 cm, Finish, Satin



**Goldmann-Fox**

**QDI-5-293-13**

Gum Scissors  
13cm, Finish, Satin



**Wagner**

**QDI-5-294-12**

Operating Scissors  
12 cm, Finish, Satin

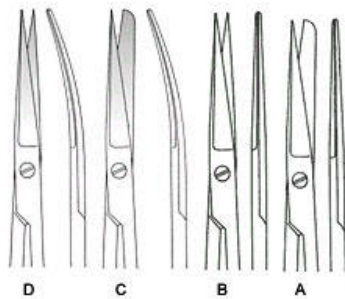

**Operating Scissors**

**QDI-5-295-12**

Operating Scissors small model  
12 cm, Finish, Satin

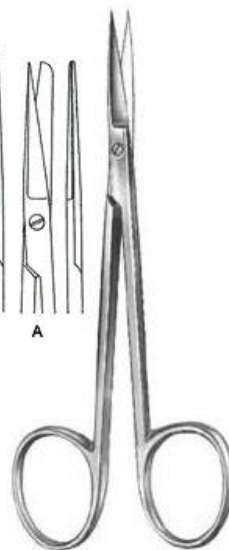

**La Grange**

**QDI-5-296-11**

Gum Scissors S-shaped  
11.5cm, Finish, Satin





**Dissecting Scissors**

**QDI-5-297-11**

Dissecting Scissors  
11.5cm, Finish, Satin



**Locklin**

**QDI-5-298-16**

Gum Scissors  
16 cm, Finish, Satin



**Locklin**

**QDI-5-299-16**

Gum Scissors  
16 cm, Finish, Satin



**Operating Scissors**

**QDI-5-300-08**

Operating Scissors  
9, Finish, Satin

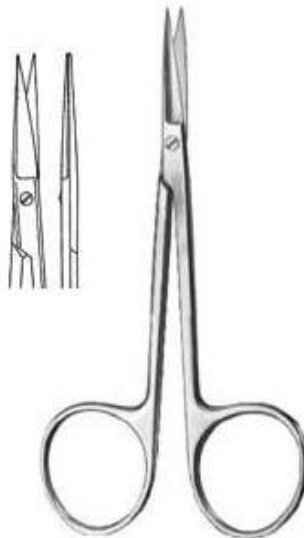

**Iris Scissors**

**QDI-5-301-10**

Iris Scissors  
9 cm, 10 cm, Finish, Satin

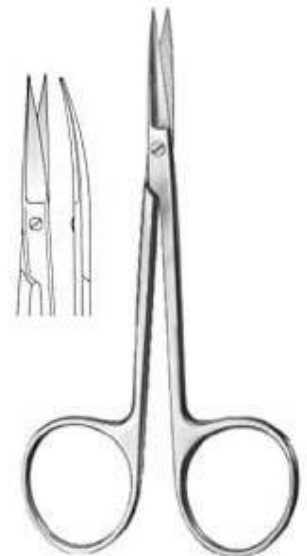

**Iris Scissors**

**QDI-5-302-10**

Iris Scissors  
10 cm, Finish, Satin



**Iris Scissors**  
**QDI-5-303-10**  
Iris Scissors  
10 cm , Finish, Satin



**Bonn**  
**QDI-5-304-09**  
Iris Scissors



**Dean**  
**QDI-5-278-17**  
Tonsil Scissors  
17.5 cm, Finish, Satin



**Spencer Scissor**  
**QDI-0-**  
Spencer Scissor



**Standard**

**QDI-5-401-10**

Dressing Forceps

10.5 cm , 11.5cm, 13cm, 14.5 cm , 16 cm, 18 cm,  
20cm, 23 cm , 25 cm , 30.5 cm, Polish Finish, Satin



**Standard**

**QDI-5-402-11**

Dressing Forceps

12 cm, 13cm, 14.5 cm , 16 cm, 18 cm, 20cm, 25  
cm , 30 cm, Polish Finish, Satin



**Dressing Forceps**

**QDI-5-403-13**

Dressing Forceps

13cm, 14.5 cm , Finish, Satin



**Stille**

**QDI-5-404-15**

Dressing Forceps

15 cm, Polish Finish, Satin



**Mini-Adson**

**QDI-5-405-12**

Dressing Forceps

12 cm, Finish, Finish



**Adson**

**QDI-5-406-12**

Dressing Forceps

12 cm, 15 cm, Finish, Satin



**McIndoe**  
**QDI-5-405-12**  
Dressing Forceps  
Finish, Satin, 15 cm



**Waugh**  
**QDI-5-408-20**  
Dressing Forceps  
20cm, Finish, Satin



**Semken**  
**QDI-5-409-12**  
Dressing Forceps  
Finish, Satin, 12.5 cm, 15 cm



**Taylor**  
**QDI-5-410-17**  
Dressing Forceps  
12.5 cm, 15 cm, Finish, Satin



**Taylor**  
**QDI-5-411-17**  
Dressing Forceps  
17 cm, Finish, Satin



**Taylor**  
**QDI-5-412-17**  
Dressing Forceps  
18.5 cm, Finish, Satin



**Dressing Forceps**

**QDI-5-413-06**

Dressing Forceps  
15.5 cm, Finish, Satin



**Gerald**

**QDI-5-414-18**

Dressing Forceps  
Finish, Satin, 15.5 cm



**Cushing**

**QDI-5-415-17**

Dressing Forceps  
Finish, Satin, 17.5 cm



**Potts-Smith**

**QDI-5-416-18**

Dressing Forceps  
18 cm, 21cm, 24.5 cm, Finish, Satin



**Bonney**

**QDI-5-417-17**

Dissecting Forceps  
17.5 cm, Finish, Satin



**Gerald**

**QDI-5-418-17**

17.5 cm, Finish, Satin



**Gillies**

**QDI-5-419-15**

Dissecting Forceps  
15.5 cm, Finish, Satin



**McIndoe**

**QDI-5-420-15**

Dressing Forceps  
15 cm, Finish, Satin



**Semken**

**QDI-5-421-16**

Dissecting Forceps  
15.5 cm, 17.5 cm, Finish, Satin



**Adson-Brown**

**QDI-5-422-12**

Dissecting Forceps  
12 cm, Finish, Satin



**Adson**

**QDI-5-423-12**

Dissecting Forceps  
12 cm, 15 cm, Finish, Satin



**Adson**

**QDI-5-424-12**

Dressing Forceps  
12 cm, 15 cm, Finish, Satin



**Cushing**

**QDI-5-425-17**

Dressing Forceps  
17.5 cm, Finish, Satin



**Cushing**

**QDI-5-426-18**

Dressing Forceps  
17 cm, Finish, Finish



**Cushing-Taylor**

**QDI-5-427-18**

Dressing Forceps  
18.5 cm, Finish, Satin



**Potts-Smith**

**QDI-5-428-15**

Dressing Forceps  
16 cm, 18.5 cm, 20cm, 23 cm, 25 cm, Finish,  
Satin



**Oehler**

**QDI-5-429-14**

Dissecting Forceps  
14.5 cm, 16 cm, 18 cm, 20cm, 25 cm, Finish,  
Satin



**Wangensteen**

**QDI-5-430-15**

Dressing Forceps  
15 cm, 23 cm, Finish, Satin



**DeBakey**

**QDI-5-421-16**

Atraumatic Dressing Forceps  
16 cm, 20cm, 24.5 cm, Finish, Satin



**DeBakey**

**QDI-5-432-16**

Atraumatic Dressing Forceps  
16 cm, 20cm, 24 cm , Finish, Satin

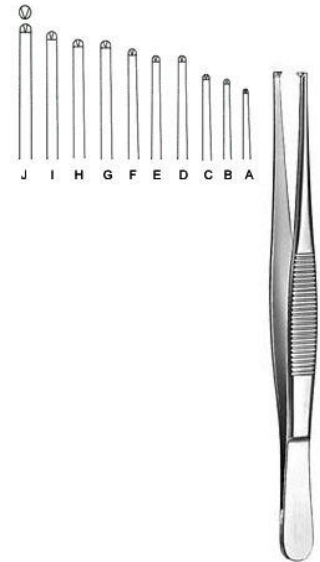

**Dissecting Forceps**

**QDI-5-433-10**

Dissecting Forceps  
10.5 cm , 11.5cm, 13 cm , 14.5 cm , 16 cm, 18 cm,  
20cm, 23 cm , 25 cm , 30.5 cm, Finish, Satin

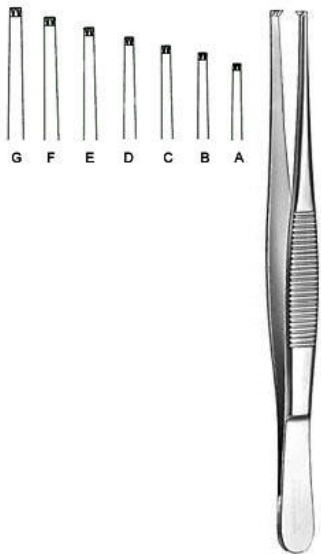

**Dissecting Forceps**

**QDI-5-434-11**

Dissecting Forceps  
12 cm, 13 cm , 14.5 cm , 15.5 cm, 18 cm, 20cm,  
24.5 cm, Finish, Satin



**Dissecting Forceps**

**QDI-5-435-14**

Dissecting Forceps  
14.5 cm , 16 cm, Finish, Satin



**Dissecting Forceps**

**QDI-5-436-14**

Dissecting Forceps  
14.5 cm , 16 cm, Finish, Satin





**Dissecting Forceps**

**QDI-5-437-13**

Dissecting Forceps

13 cm , 14.5 cm , 16 cm, 20cm, Finish, Satin



**Dissecting Forceps**

**QDI-5-438-13**

Dissecting Forceps

13 cm , 14.5 cm , Finish, Satin



**Stille**

**QDI-5-439-15**

Dissecting Forceps

15 cm, Finish, Satin



**Stille**

**QDI-5-440-15**

Dissecting Forceps

15 cm, Finish, Satin



**Stone**

**QDI-5-441-15**

Dissecting Forceps

15 cm, Finish, Satin



**Lerche**

**QDI-5-442-15**

Dissecting Forceps

15 cm, Finish, Satin



**Adlerkreutz**

**QDI-5-443-15**

Dissecting Forceps

15.5 cm, 20.5 cm, 16 cm, 20cm, 25 cm , Finish, Satin

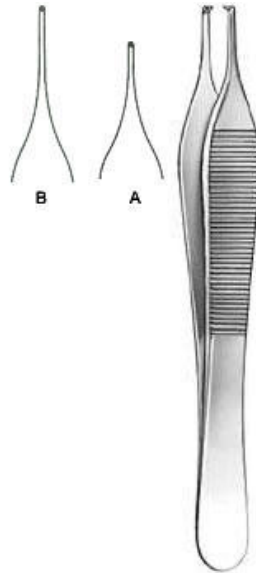

**Adson**

**QDI-5-444-12**

Dissecting Forceps

12 cm, 15 cm, Finish, Satin



**Gillies**

**QDI-5-445-15**

Dissecting Forceps

15.5 cm, Finish, Satin



**Waugh**

**QDI-5-446-20**

Dissecting Forceps

20.5 cm, Finish, Satin



**Semken**

**QDI-5-447-12**

Dissecting Forceps

12.5 cm, 15 cm, Finish, Satin



**Taylor**

**QDI-5-448-17**

Dissecting Forceps

17.5 cm, Finish, Satin



**Taylor**

**QDI-5-449-17**

Dissecting Forceps  
17 cm , Finish, Satin



**Taylor**

**QDI-5-450-17**

Dissecting Forceps  
18.5 cm , Finish, Satin



**Dissecting Forceps**

**QDI-5-451-06**

Dissecting Forceps  
15.5 cm, Finish, Satin



**Gerald**

**QDI-5-452-17**

Dissecting Forceps  
17.5 cm, Finish



**Cushing**

**QDI-5-453-17**

Dissecting Forceps  
18 cm, Finish, Satin



**Potts-Smith**

**QDI-5-454-18**

Dissecting Forceps  
18 cm, 21cm, 24 cm , Finish, Satin

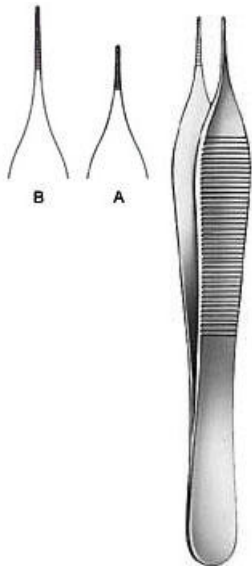

**Mikro-Adson**  
**QDI-5-455-12**  
Dressing Forceps  
12 cm, 15 cm, Finish, Satin

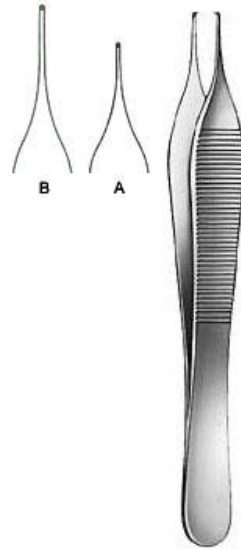

**Mikro-Adson**  
**QDI-5-456-12**  
Dissecting Forceps  
12 cm, 15 cm, Finish, Satin



**Dissecting Forceps**  
**QDI-5-457-11**  
Dissecting Forceps  
10.5 cm, Finish, Satin



**Micro Jewelers**  
**QDI-5-458-12**  
Jeweler Type Forceps  
Finish, Satin, 12 cm Fig. 7



**Jewelers**  
**QDI-5-459-12**  
Jeweler Type Forceps  
12 cm Fig. 3, Finish, Satin



**Jewelers**  
**QDI-5-460-11**  
Jeweler Type Forceps  
Polish Finish, Satin, 11 cm Fig. 3c



**Jewelers**

**QDI-5-461-11**

Jeweler Type Forceps  
Polish Finish, Satin, 11 cm Fig. 5



**Jewelers**

**QDI-5-462-11**

Jeweler Type Forceps  
Finish, Satin, 11 cm Fig. 4



**Stille-Barraya**

**QDI-5-463-18**

Dissecting Forceps  
Finish, Satin, 18 cm



**Bonney**

**QDI-5-464-18**

Dissecting Forceps  
17.5 cm, Finish, Satin



**Nelson**

**QDI-5-465-23**

Dissecting Forceps  
23 cm, Finish, Satin



**Dressing Forceps**

**QDI-5-466-10**

Dressing Forceps  
10 cm, 9.5 cm, Finish, Satin



**Splinter Forceps Smooth Jaw**

**QDI-5-467-12**

Splinter Forceps smooth jaw  
12.5 cm, Finish, Satin



**Splinter Forceps Smooth Jaw**

**QDI-5-468-12**

Splinter Forceps smooth jaw  
12.5 cm, Finish, Satin



**Splinter Forceps**

**QDI-5-469-12**

Splinter Forceps  
12.5 cm, Finish, Satin



**Splinter Forceps**

**QDI-5-470-12**

Splinter Forceps  
12.5 cm, Finish, Satin



**Micro Tying Forceps**

**QDI-5-471-16**

Micro Tying Forceps  
15.5 cm, Finish, Satin



**Microscopic Forceps Super Light,  
Blunt**

**QDI-5-472-10**

Microscopic Forceps super light, blunt  
10 cm, Finish, Satin



**Microscopic Forceps**

**QDI-5-473-10**

Microscopic Forceps  
10 cm , Finish, Satin



**Shaaf**

**QDI-5-474-09**

Splinter Forceps  
9.5 cm, Finish, Satin



**Littauer**

**QDI-5-475-08**

Cilia Forceps  
8.5 cm, Finish, Satin



**Cilia Forceps**

**QDI-5-476-09**

Cilia Forceps  
8.5 cm, Finish, Satin



**Douglas**

**QDI-5-477-09**

Cilia Forceps  
9 cm, Finish, Satin



**Douglas**

**QDI-5-478-09**

Cilia Forceps  
9 cm, Finish, Satin



**Beer**

**QDI-5-479-09**

Cilia Forceps  
9 cm, Finish, Satin





**Phaneuf**

**QDI-5-501-21**

Hysterectomy Forceps  
20.5 cm, Finish, Satin



**Wertheim-Cullen**

**QDI-5-502-21**

Vaginal Clamp  
21 cm, Finish, Satin

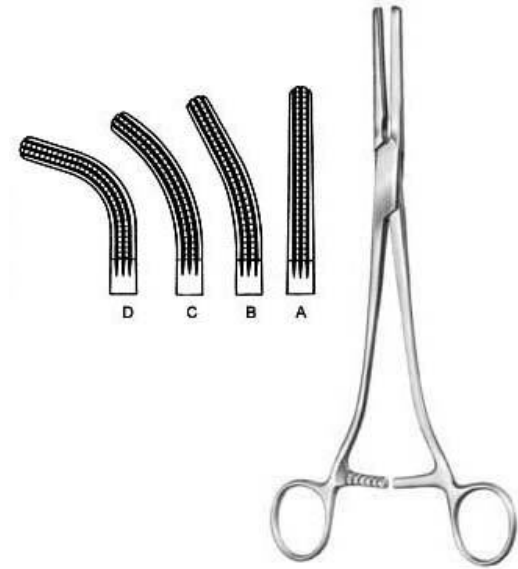

**Rogers**

**QDI-5-503-10**

Hysterectomy Forceps  
21.5 cm Fig. 1, 21 cm Fig. 2, 20.5 cm Fig. 3, 20 cm Fig. 4, Finish, Satin



**Moynihan**

**QDI-5-504-23**

Hysterectomy Forceps  
23 cm, Finish, Satin



**Moynihan**

**QDI-5-505-24**

Hysterectomy Forceps  
23.5 cm, Finish, Satin



**Wertheim**

**QDI-5-506-25**

Hysterectomy Forceps  
26 cm, Finish, Satin

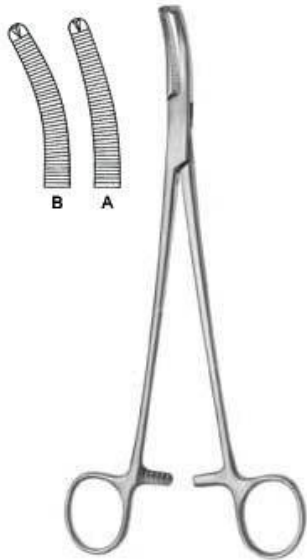

**Wertheim**

**QDI-5-507-22**

Hysterectomy Forceps  
22.5 cm, Finish, Satin



**Mikulicz, Baby**

**QDI-5-508-14**

Peritoneum Forceps  
Finish, Satin, 14.5 cm



**Mikulicz**

**QDI-5-509-18**

Peritoneum Forceps  
20.5 cm, Finish, Satin



**Mikulicz**

**QDI-5-510-20**

Peritoneum Forceps  
18.5 cm, Finish, Satin



**Mikulicz**

**QDI-5-511-20**

Peritoneum Forceps  
20cm, Finish, Satin



**Mikulicz**

**QDI-5-512-21**

Peritoneum Forceps  
20.5 cm, Finish, Satin



**Faure**

**QDI-5-513-20**

Peritoneum Forceps  
21 cm, Finish, Satin

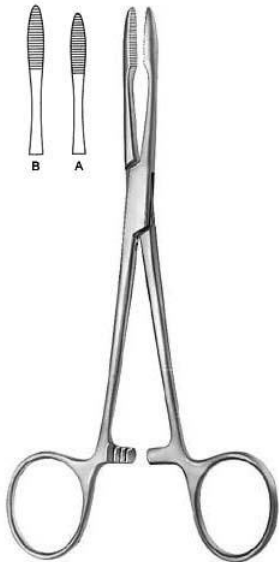

**Pean**

**QDI-5-601-14**

Haemostatic Forceps  
14.5 cm , 16 cm, Finish, Satin

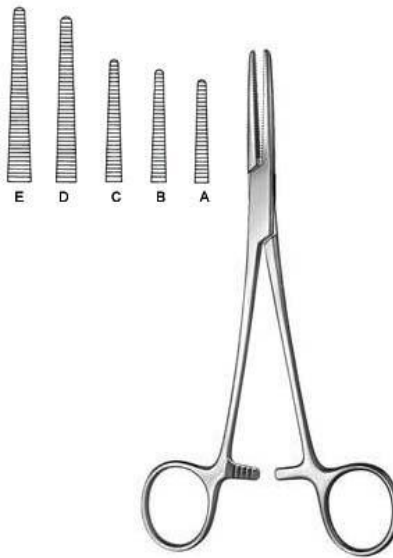

**Spencer-Wells**

**QDI-5-602-13**

Haemostatic Forceps  
13 cm , 14 cm, 15.5 cm , 18.5 cm , 20 cm, Finish,  
Satin

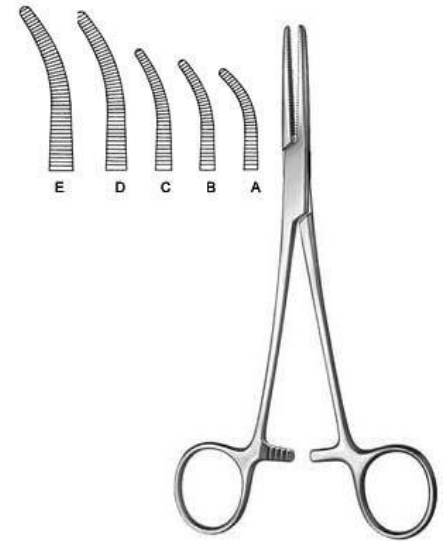

**Spencer-Wells**

**QDI-5-603-13**

Haemostatic Forceps  
13 cm , 14 cm, 15 cm, 18 cm, 20 cm, Finish, Satin



**Chaput**

**QDI-5-604-13**

Haemostatic Forceps  
12.5 cm, Finish, Satin



**Tuffier**

**QDI-5-605-13**

Haemostatic Forceps  
Finish, Satin, 12.5 cm

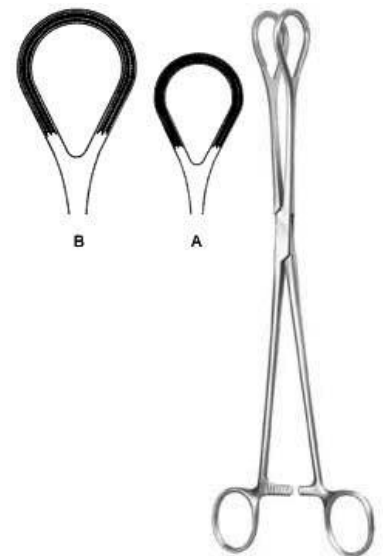

**Grasping Forceps**

**QDI-5-606-25**

Organ Grasping Forceps  
Finish, Satin



**Collin**

**QDI-5-607-14**

Organ Grasping Forceps  
12.5 cm, 21 cm, Finish, Satin



**Collin**

**QDI-5-608-17**

Tumor Grasping Forceps  
17 cm, Finish, Satin



**Pennington**

**QDI-5-609-15**

Haemostatic Forceps  
15.5 cm, Finish, Satin



**Pratt**

**QDI-5-610-15**

Haemostatic Forceps  
15 cm, Finish, Satin



**Martel-Rees**

**QDI-5-611-14**

Face-lift Forceps  
13.5 cm, Finish, Satin



**Ligature Forceps**

**QDI-5-612-12**

Ligature Forceps

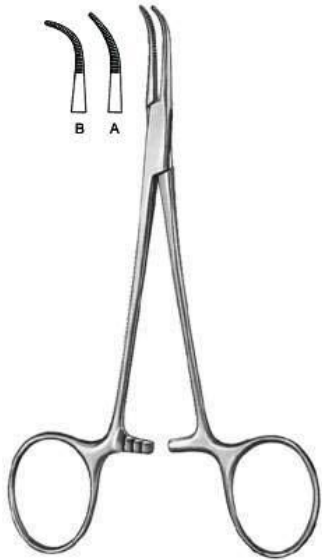

**Mixer-Baby**  
QDI-5-613-01

Dissecting and Ligature Forceps  
13 cm , 13.5 cm , Finish, Satin

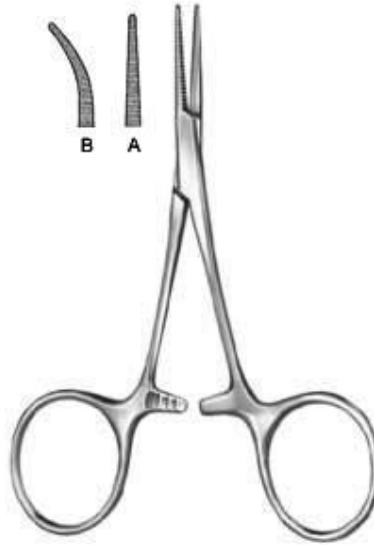

**Hartmann**  
QDI-5-614-10

Haemostatic Forceps  
Finish, Satin, 9.5 cm, 10 cm



**Ligature Forceps**  
QDI-5-615-12

Ligature Forceps

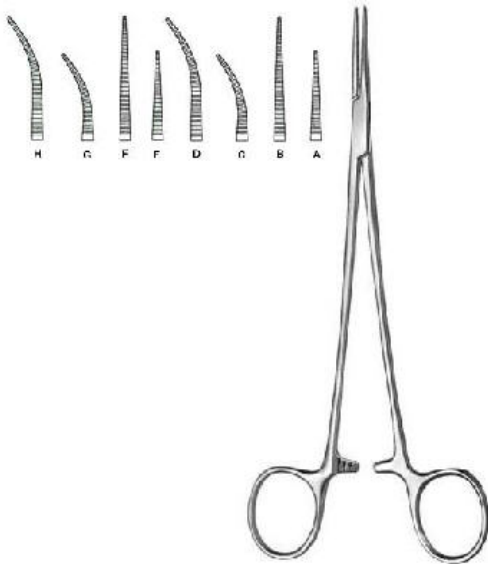

**Halsted-Mosquito**  
QDI-5-616-18

Haemostatic Forceps  
12.5 cm, 14 cm, 14.5 cm , Finish, Satin

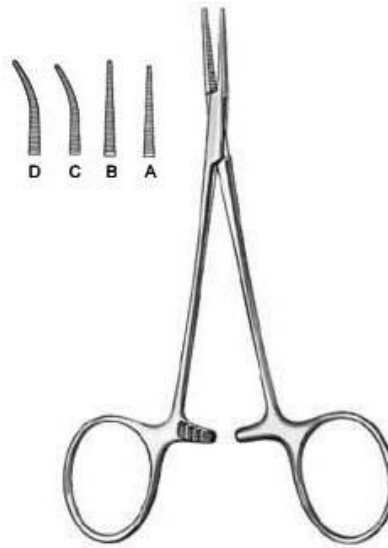

**Mikro-Mosquito**  
QDI-5-617-10

Haemostatic Forceps  
9.5 cm, 10 cm , 11.5 cm, 12 cm, Finish, Satin



**Providence-Hospital**  
QDI-5-618-14

Haemostatic Forceps  
14 cm, Finish, Satin



**Leriche**

**QDI-5-619-15**

Haemostatic Forceps  
15 cm, 15.5 cm, Finish, Satin

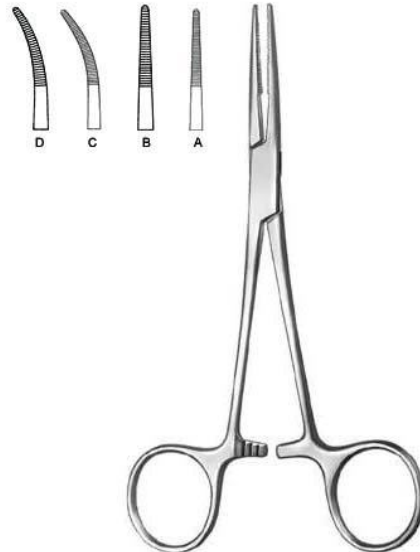

**Kelly**

**QDI-5-620-14**

Haemostatic Forceps  
14 cm, 14.5 cm, Finish, Satin

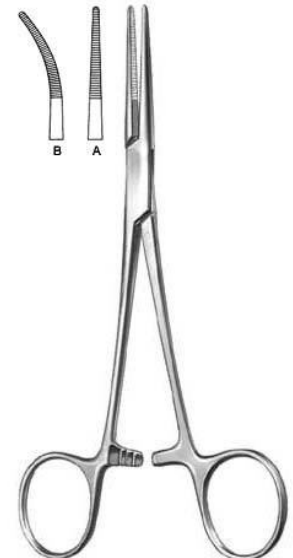

**Kelly-Rankin**

**QDI-5-621-16**

Haemostatic Forceps  
15.5 cm, 16 cm, Finish, Satin



**Overholt-Baby**

**QDI-5-622-14**

Dissecting and Ligature Forceps  
14 cm, 14.5 cm, Finish, Satin

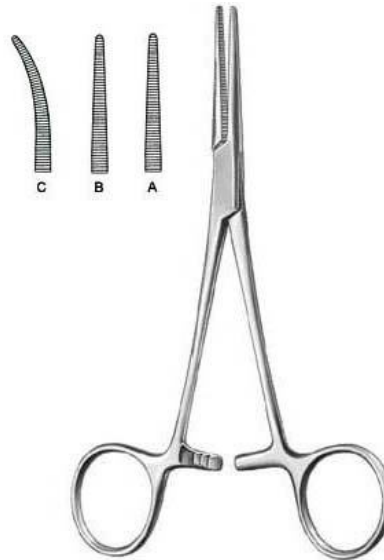

**Crile**

**QDI-5-623-14**

Haemostatic Forceps  
14 cm, 14.5 cm, Finish, Satin



**Crile-Rankin**

**QDI-5-624-16**

Haemostatic Forceps  
16 cm, 16.5 cm, Finish, Satin

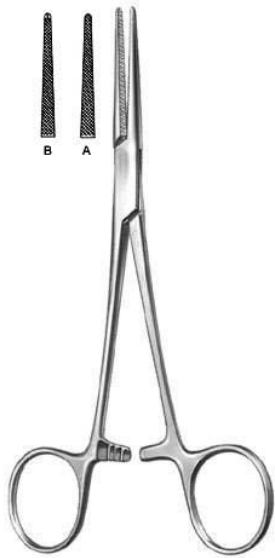

**Lovelace**

**QDI-5-625-15**

Haemostatic Forceps  
16 cm, Finish, Satin



**Dandy-Mosquito**

**QDI-5-626-12**

Haemostatic Forceps  
12 cm, Finish, Satin

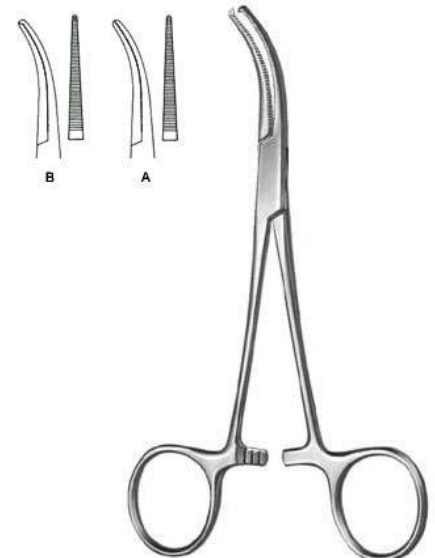

**Dandy**

**QDI-5-627-14**

Haemostatic Forceps  
14 cm, 14.5 cm, Finish, Satin



**Schidt**

**QDI-5-628-18**

Dissecting and Ligature Forceps  
18.5 cm, 19 cm, Finish, Satin



**Adson**

**QDI-5-629-18**

Dissecting and Ligature Forceps  
18.5 cm, 19 cm, Finish, Satin



**Martin-Fuchsig**

**QDI-5-630-20**

Dissecting and Ligature Forceps  
20.5 cm, Finish, Satin



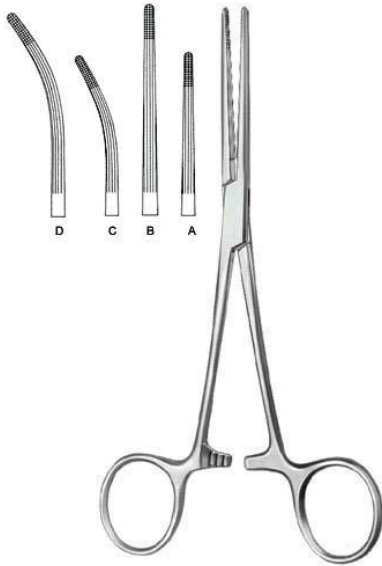

**Rochester-Carmalt**

**QDI-5-631-16**

Haemostatic Forceps

16.5 cm, 17 cm, 20 cm, 20.5 cm, Finish, Satin

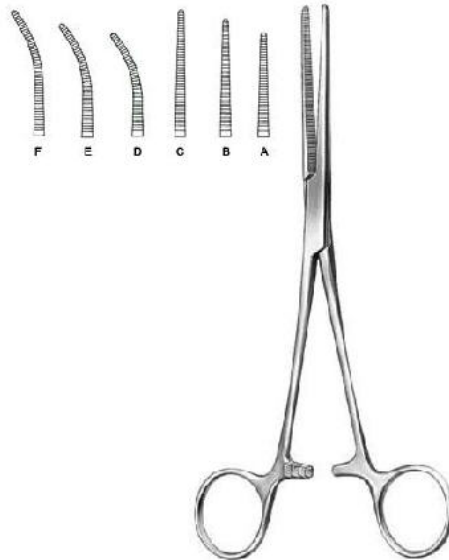

**Pean**

**QDI-5-632-13**

Haemostatic Forceps

13 cm, 13.5 cm, 14 cm, 14.5 cm, 16.5 cm, 17 cm, Finish, Satin

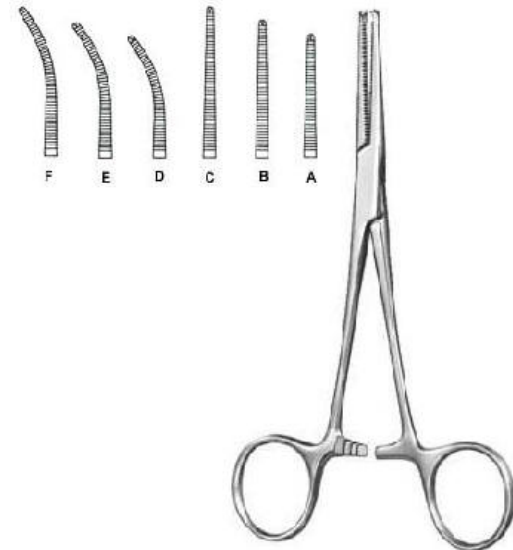

**Kocher-Nippon**

**QDI-5-633-14**

Haemostatic Forceps

14.5 cm, 16 cm, 16.5 cm, 18 cm, 18 cm, Finish, Satin

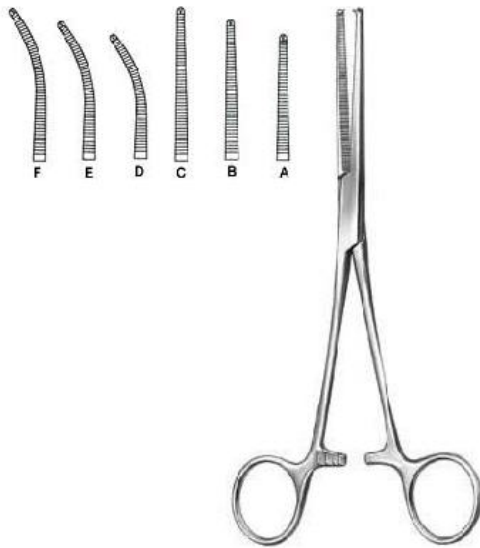

**Kocher**

**QDI-5-635-13**

Haemostatic Forceps

13 cm, 14 cm, 16 cm, Finish, Satin

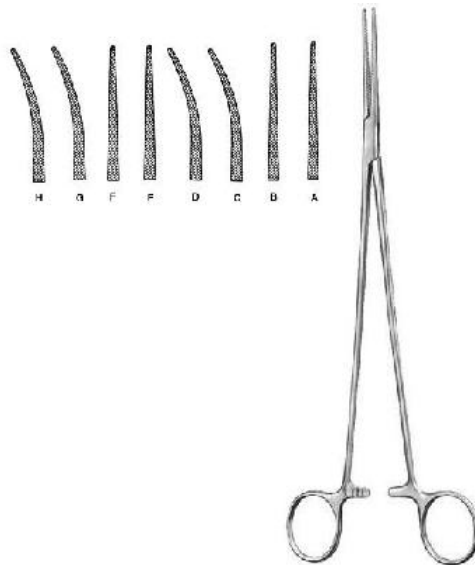

**Bengolea**

**QDI-5-636-20**

Haemostatic Forceps

21 cm, 21.5 cm, 26 cm, Finish, Satin

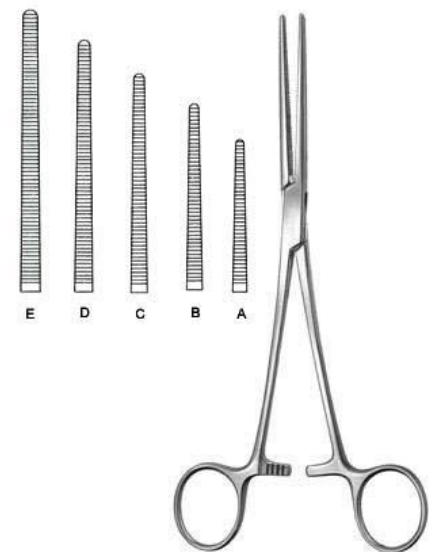

**Pean (Rochester)**

**QDI-5-637-14**

Haemostatic Forceps

14 cm, 14.5 cm, 16 cm, 16.5 cm, 18.5 cm, 20.5 cm, 22.5 cm, 24.5 cm, 26 cm, 30.5 cm, Finish, Satin

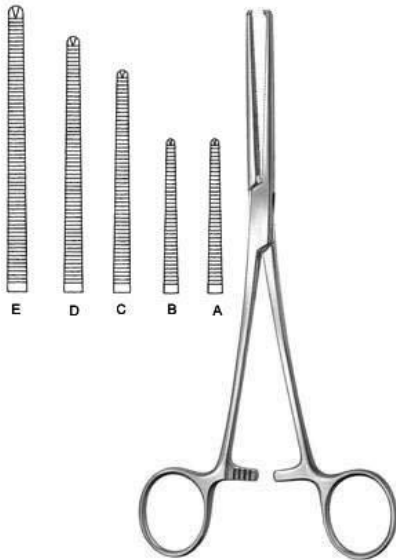

**Kocher (Ochsner)**

**QDI-5-638-14**

Haemostatic Forceps

14.5 cm , 16.5 cm , 18.5 cm , 20.5 cm , 22.5 cm ,  
24.5 cm , 26 cm , 30.5 cm , Finish, Satin

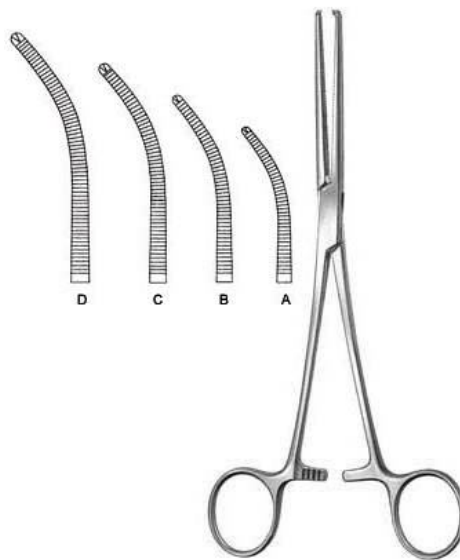

**Kocher (Ochsner)**

**QDI-5-639-14**

Haemostatic Forceps

14 cm , 16 cm , 18 cm , 20 cm , 22 cm , 24 cm , 25.5  
cm , 30 cm , Finish, Satin

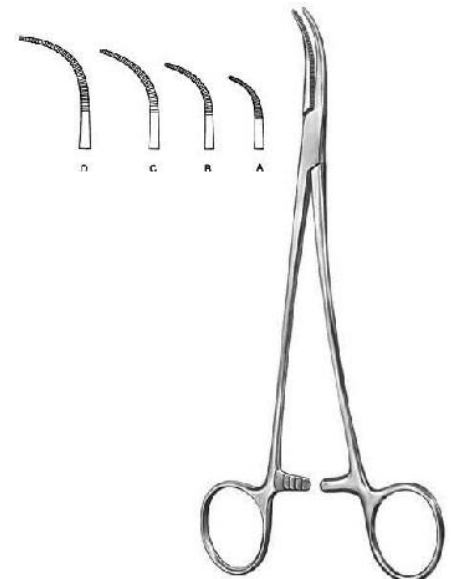

**Overholt-Martin**

**QDI-5-640-01**

Dissecting and Ligature Forceps

18.5 cm Fig. 1 , 20.5 cm Fig. 2 , 21 cm Fig. 3 , 21.5  
cm Fig. 4 , 24.5 cm Fig. 5 , Finish, Satin



**Mixer-Baby**

**QDI-5-641-18**

Dissecting and Ligature Forceps

18.5 cm , Finish, Satin



**Adson-Baby**

**QDI-5-642-14**

Dissecting and Ligature Forceps

14.5 cm , 18 cm , Finish, Satin



**Heiss**

**QDI-5-643-20**

Dissecting and Ligature Forceps

20 cm , 20.5 cm , 21 cm , Finish, Satin



**Overholt-Mixter**

**QDI-5-644-21**

Dissecting and Ligature Forceps  
21.5 cm, Finish, Satin

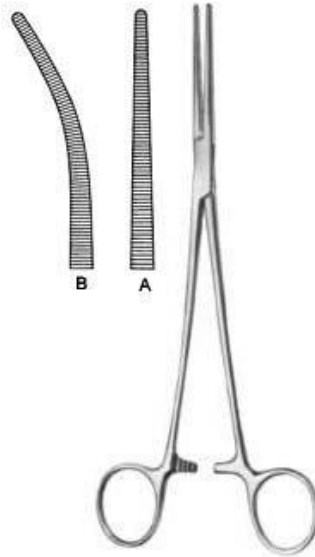

**Roberts**

**QDI-5-645-22**

Dissecting and Ligature Forceps  
21.5 cm, 22.5 cm, Finish, Satin

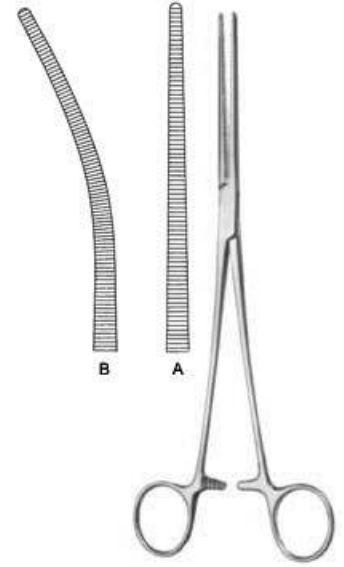

**Sarot**

**QDI-5-646-24**

Dissecting and Ligature Forceps  
24.5 cm, 25 cm, Finish, Satin

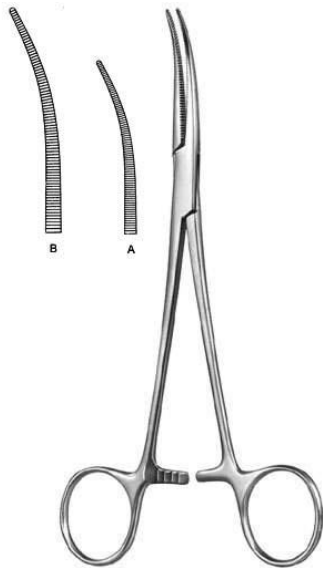

**Crafoord**

**QDI-647-18**

Dissecting and Ligature Forceps  
18 cm, 24.5 cm, Finish, Satin

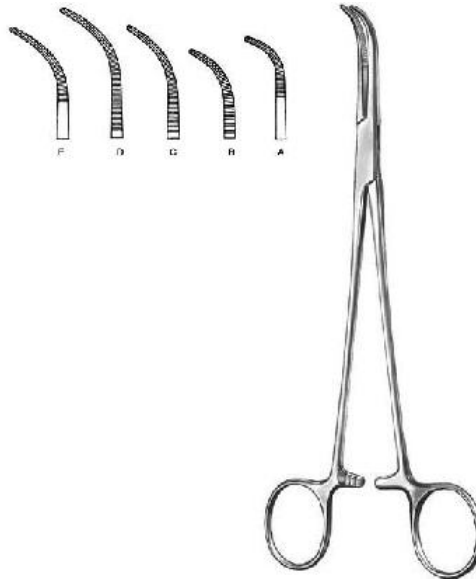

**Overholt-Geissendorfer**

**QDI-5-648-01**

Dissecting and Ligature Forceps  
20.5 cm Fig. 1, 20 cm Fig. 2, 21.5 cm Fig. 3, 22 cm  
Fig. 4, 21.5 cm Fig. 5, 22 cm Fig. 6, 27 cm Fig. 1,  
26.5 cm Fig. 2, 27.5 cm Fig. 3, 28 cm Fig. 4,  
Finish, Satin

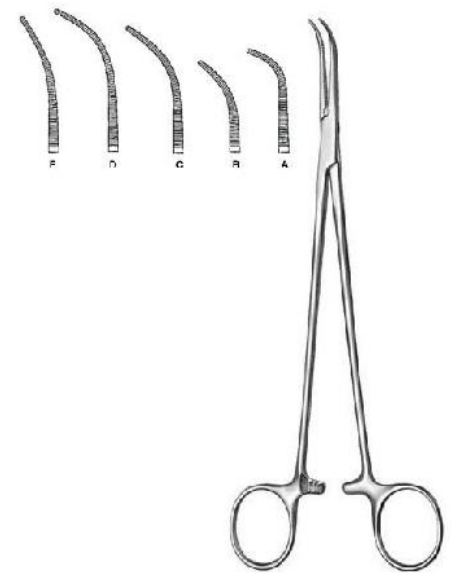

**Overholt-Fino**

**QDI-5-649-00**

Dissecting and Ligature Forceps  
21 cm, 21.5 cm, 22 cm, 22.5 cm, 23 cm, Finish,  
Satin

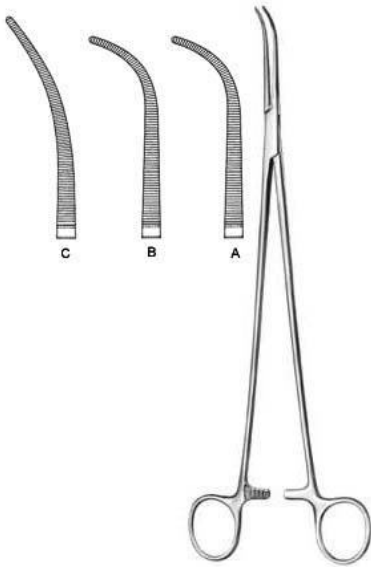

**Overholt**

**QDI-5-650-00**

Dissecting and Ligature Forceps  
29.5 cm, 30 cm, Finish, Satin



**Overholt-Mini**

**QDI-5-651-01**

Dissecting and Ligature Forceps  
15 cm, 20 cm, Finish, Satin

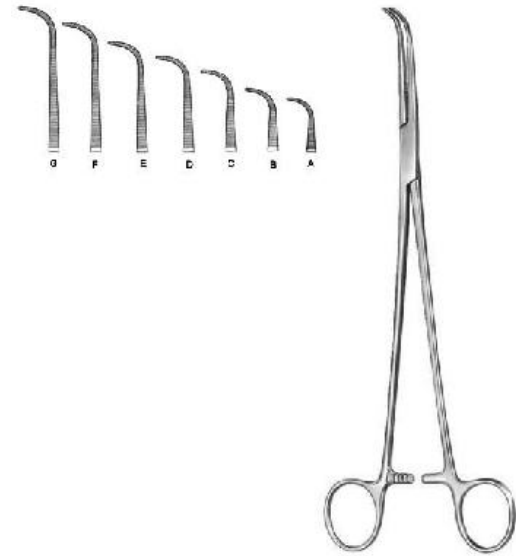

**Gemini**

**QDI-5-652-13**

Dissecting and Ligature Forceps  
13 cm , 16 cm, 18 cm, 21 cm, 23 cm , 25 cm , 28 cm,  
Finish, Satin

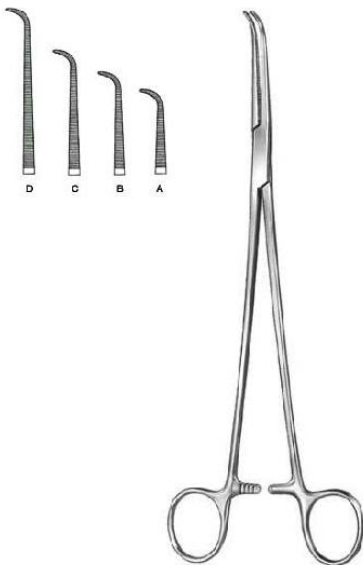

**Mini-Gemini**

**QDI-5-653-18**

Dissecting and Ligature Forceps  
18 cm, 22.5 cm, 25 cm , 28.5 cm, Finish, Satin

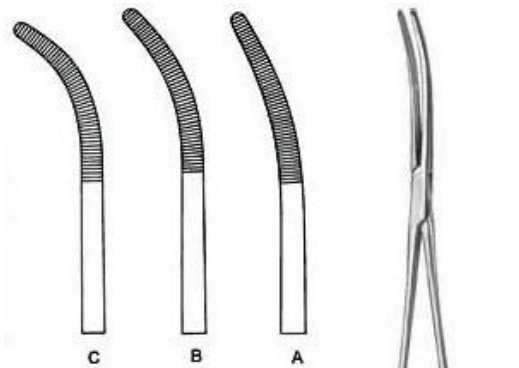

**Rumel**

**QDI-5-654-01**

Dissecting and Ligature Forceps  
24 cm Fig. 1 , 23.5 cm Fig. 2 , 23 cm Fig. 3, 24 cm Fig. 4  
, 23.5 cm Fig. 5, Finish, Satin

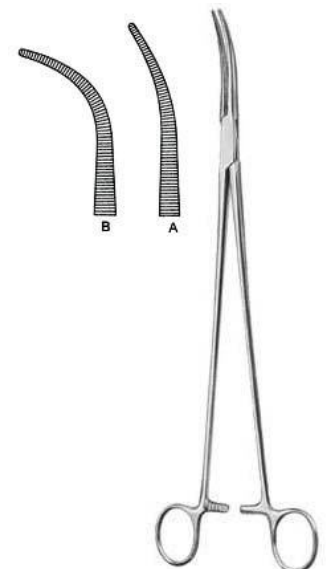

**Zenker**

**QDI-5-655-01**

Dissecting and Ligature Forceps  
28.5 cm, 29.5 cm, Finish, Satin



**Mixer-Baby**

**QDI-5-656-14**

Dissecting and Ligature Forceps  
13.5 cm , Finish, Satin



**Mixer**

**QDI-5-657-15**

Dissecting and Ligature Forceps  
16 cm, 18 cm, Finish, Satin



**Mixer-O Shaugnessy**

**QDI-5-658-19**

Dissecting and Ligature Forceps  
18 cm, Finish, Satin



**Mixer**

**QDI-5-659-22**

Dissecting and Ligature Forceps  
22.5 cm, Finish, Satin



**Mixer**

**QDI-5-660-23**

Dissecting and Ligature Forceps  
23 cm , Finish, Satin

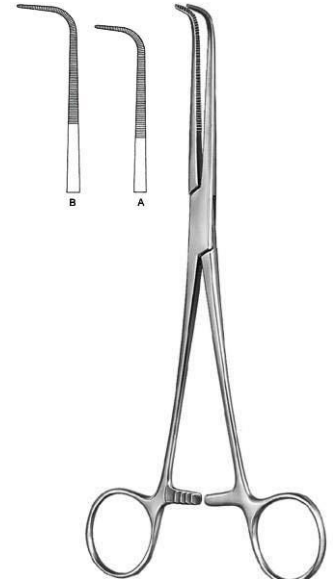

**Wickstrom**

**QDI-5-661-21**

Dissecting and Ligature Forceps  
21 cm, 24.5 cm, Finish, Satin

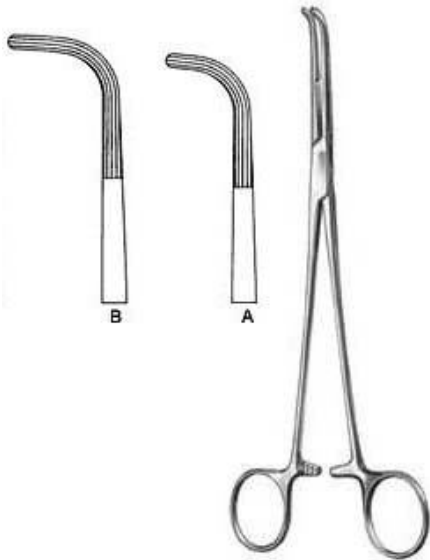

**Mixer**

**QDI-5-662-22**

Dissecting and Ligature Forceps  
22.5 cm, 26 cm, 28 cm, Finish, Satin



**Mc Quigg-Mixer**

**QDI-5-663-22**

Dissecting and Ligature Forceps  
23.5 cm, Finish, Satin



**Lower**

**QDI-5-664-18**

Dissecting and Ligature Forceps  
18.5 cm, Finish, Satin

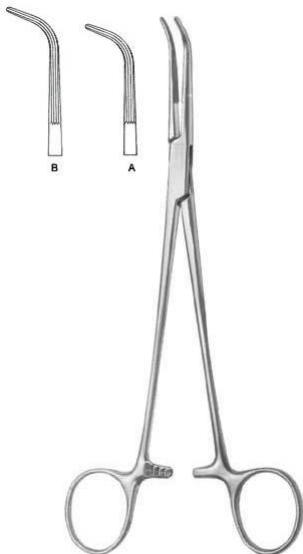

**Lahey**

**QDI-5-665-19**

Bile Duct Clamp  
19.5 cm, 22.5 cm, Finish, Satin



**Finochietto**

**QDI-5-666-24**

Dissecting and Ligature Forceps  
24 cm, Finish, Satin



**Uro-Tangential**

**QDI-5-667-01**

Tangential Forceps  
25 cm, 27 cm, Finish, Satin

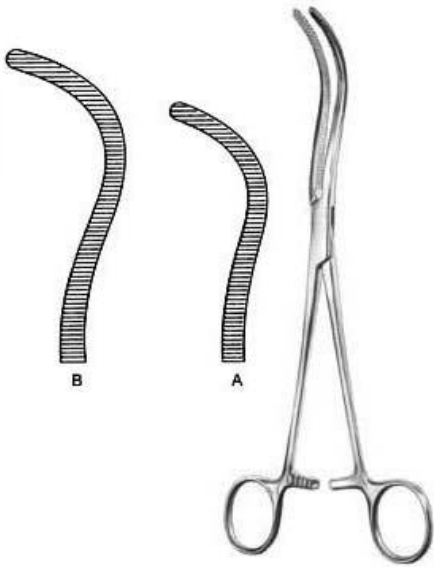

**Guyon**

**QDI-5-668-20**

Kidney Pedicle Clamp  
23 cm , 24 cm , Finish, Satin



**Guyon**

**QDI-5-669-23**

Kidney Pedicle Clamp  
19.5 cm , 21.5 cm , 24 cm , Finish, Satin



**Desjardins**

**QDI-5-670-21**

Bile Duct Clamp  
21 cm, Finish, Satin

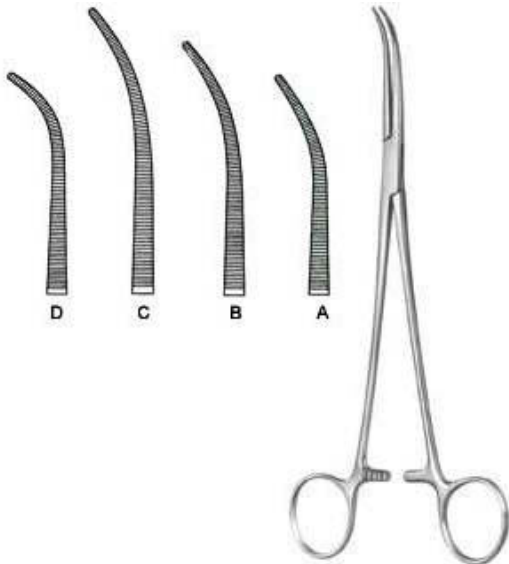

**Kelly**

**QDI-5-671-19**

Dissecting and Ligature Forceps  
19.5 cm Fig. 1 , 22.5 cm Fig. 1 , 24.5 cm Fig. 1 , 19 cm Fig. 2 , 22 cm Fig. 2 , 24 cm Fig. 2 , 18.5 cm Fig. 3 , 23.5 cm Fig. 3 , 21.5 cm Fig. 3



**Lawrence**

**QDI-5-672-28**

Dissecting and Ligature Forceps  
28 cm, Finish, Satin



**Meeker**

**QDI-5-673-28**

Dissecting and Ligature Forceps  
28 cm, Finish, Satin



**Negus**

**QDI-5-674-19**

Haemostatic Forceps

19.5 cm Fig. 1 , 20 cm Fig. 2 , Finish, Satin





**Schaedel**

**QDI-5-701-09**

Towel Clamp sharp  
9 cm, Polish Finish, Satin



**Jones**

**QDI-5-702-05**

Towel Clamp sharp  
5.5 cm, 8.5 cm, Finish, Satin



**Jones-Martin**

**QDI-5-703-09**

Towel Clamp sharp  
8.5 cm, Finish, Satin



**Backhaus**

**QDI-5-705-11**

Towel Clamp  
11.5 cm, Finish, Satin



**Backhaus**

**QDI-5-706-08**

Towel Clamp  
9 cm, 11.5 cm, 13 cm, 16 cm, Finish, Satin



**Peers-Bertram Modif.**

**QDI-5-707-15**

Towel Clamp wide jaw for tube fixation  
15.5 cm, Finish, Satin



**R?Der**

**QDI-5-708-13**

Towel Clamp  
13.5 cm , Finish, Satin

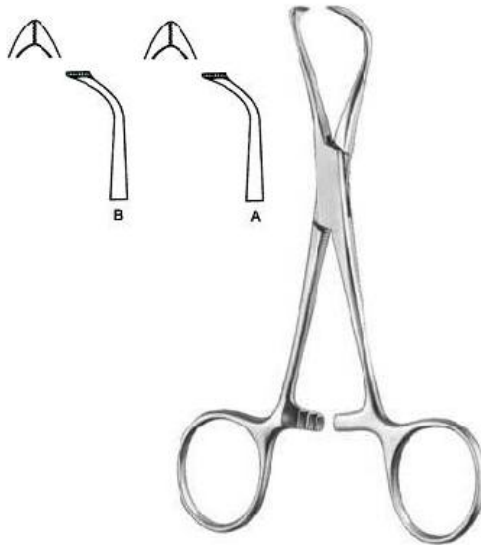

**Lorna**

**QDI-5-709-10**

Towel Clamp fine serrated, wide jaw  
9.5 cm, 13 cm , Finish, Satin



**Bernhard**

**QDI-5-710-16**

Towel Clamp  
16.5 cm, Finish, Satin

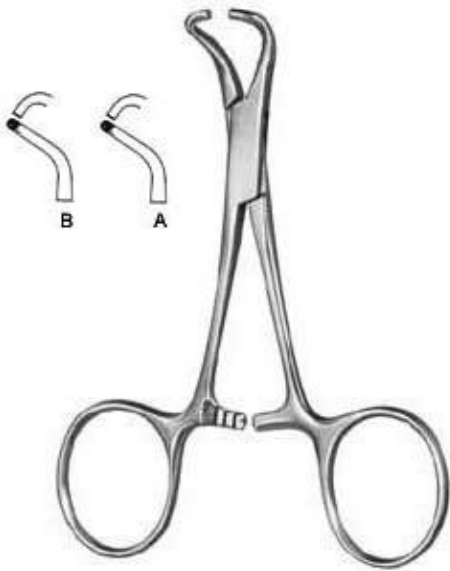

**Tohoku**

**QDI-5-711-10**

Towel Clamp  
10.5 cm blunt, Finish, Satin, 13.5 cm blunt, 14.5 cm

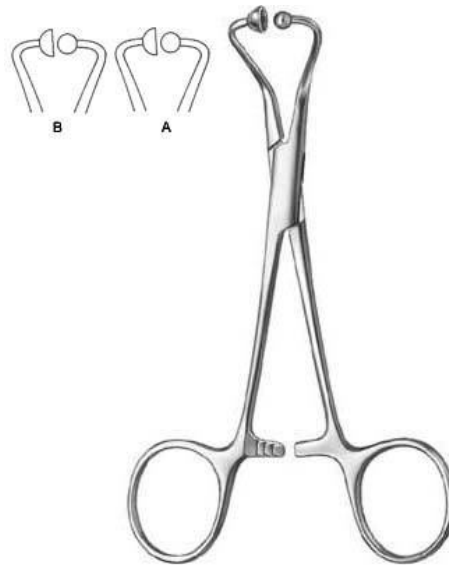

**Towel Clamp For Paper Clothes**

**QDI-5-712-11**

Towel Clamp for paper clothes  
11.5 cm, 14 cm, Finish, Satin



**Lane**

**QDI-5-713-20**

Lane  
19.5 cm , Finish, Satin



**Tube Holder For Fixation Of Six Tubes**

**QDI-5-714-06**

Tube Holder for fixation of six tubes  
Finish, Satin



**Tubing Clamp Extra Long Ratchet**

**QDI-5-715-14**

Tubing Clamp extra long ratchet  
14 cm, Finish, Satin



**Tubing Clamp**

**QDI-5-716-16**

Tubing Clamp  
16.5 cm, Finish, Satin

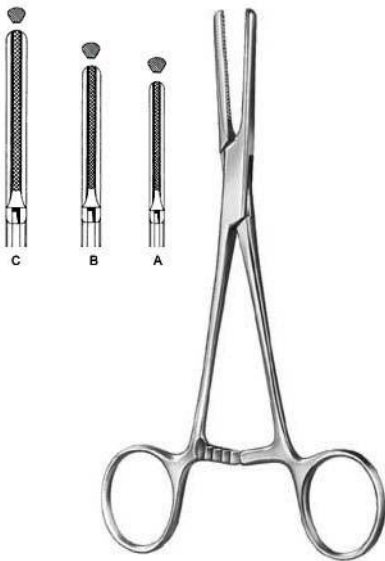

**Tubing Clamp**

**QDI-5-717-15**

Tubing Clamp  
15.5 cm, 19 cm, 20.5 cm, Finish, Satin

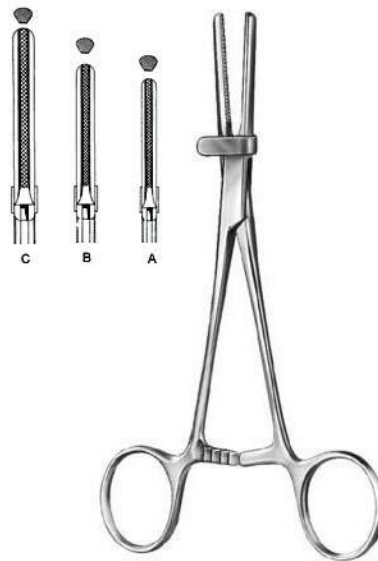

**Tubing Clamp With Safety Guard**

**QDI-5-718-15**

Tubing Clamp with safety guard  
15.5 cm, 19 cm, 20.5 cm, Finish, Satin

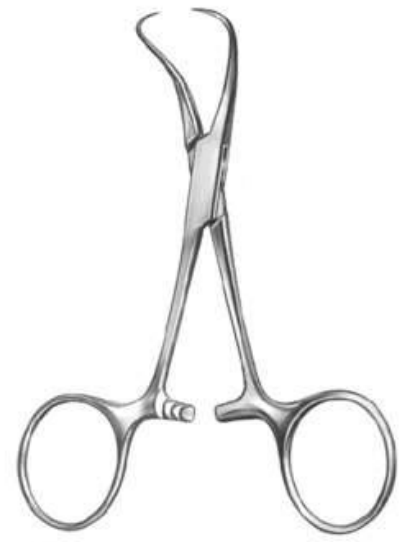

**Backhaus**

**QDI-5-704-11**

Towel Clamp  
11.5 cm, 13 cm, Finish, Satin

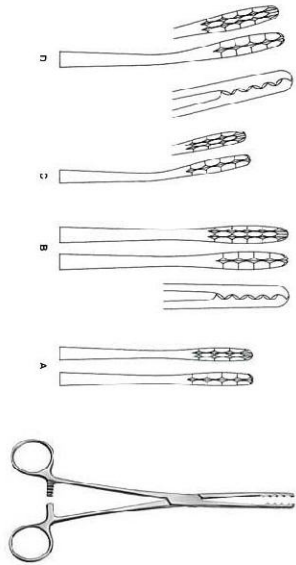

**Ulrich**

**QDI-5-801-22**

Dressing Forceps

21.5 cm, 26.5 cm, Finish, Satin

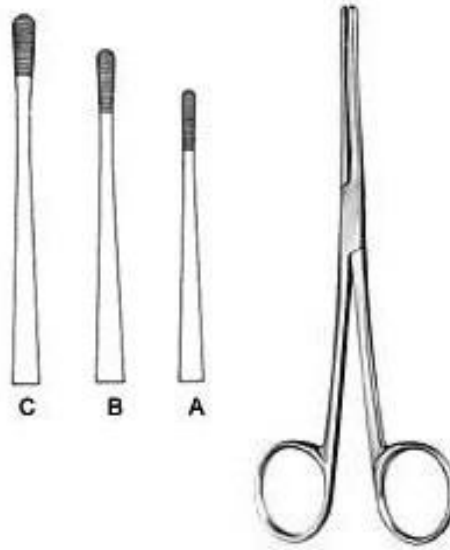

**Lister**

**QDI-5-802-13**

Sinus Forceps

13 cm, 16 cm, 18 cm, Finish, Satin



**Martin**

**QDI-5-803-17**

Dressing Forceps

17.5 cm, 17 cm, Finish, Satin

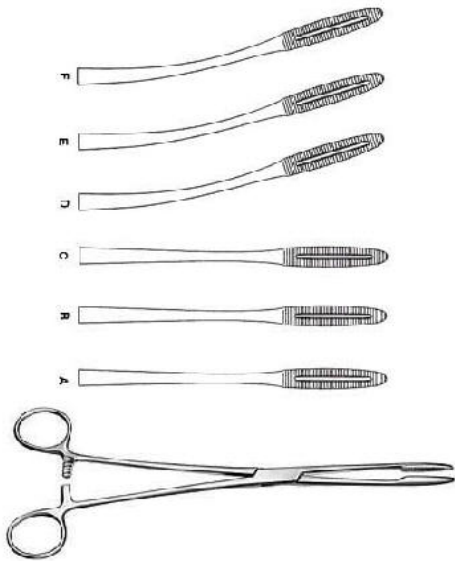

**Gross-Maier**

**QDI-5-804-20**

Dressing Forceps

20.5 cm, 22 cm, 26.5 cm, 20 cm, 21.5 cm, 26 cm,  
Finish, Satin



**Tunneling Forceps**

**QDI-5-805-40**

Tunneling Forceps

39.5 cm, Finish, Satin



**Collin**

**QDI-5-806-25**

Dressing Forceps

25.5 cm, Finish, Satin



**Cheron**

**QDI-5-807-25**

Dressing Forceps  
23.5 cm, Finish, Satin



**Bozemann**

**QDI-5-808-26**

Sponge Forceps  
26 cm, Finish, Satin

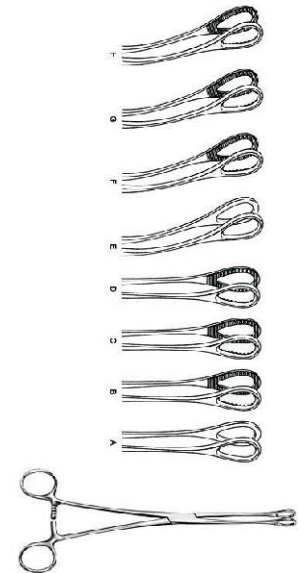

**Foerster**

**QDI-5-809-25**

Sponge Forceps  
25 cm , 18 cm, 20.5 cm, 24.5 cm, 17.5 cm, 20 cm,  
24.5 cm, Finish, Satin

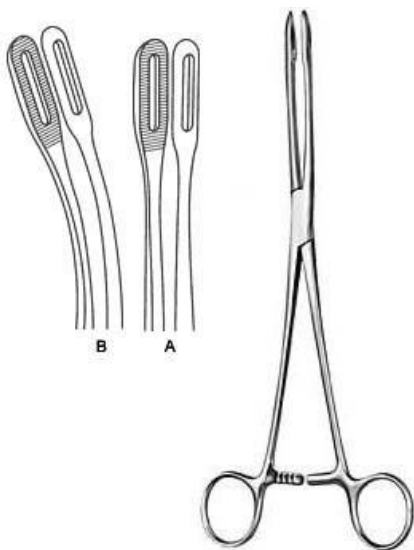

**Foerster**

**QDI-5-810-25**

Sponge Forceps  
25 cm , 24.5 cm, Finish, Satin

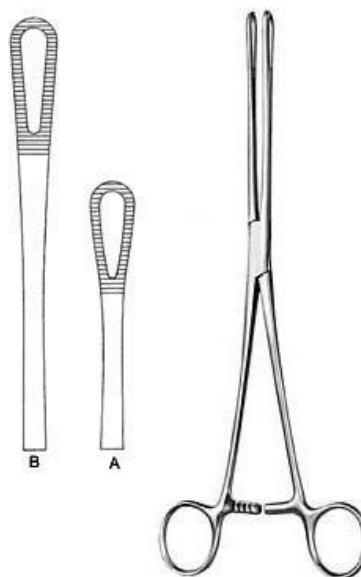

**Rampley**

**QDI-5-811-18**

Sponge Forceps  
18.5 cm , 24.5 cm, Finish, Satin



**Vickers**  
**QDI-5-901-18**  
Skin Hooklet  
18.5 cm , Finish, Satin



**Vickers**  
**QDI-5-902-01**  
Bone Hooklet  
17 cm , Finish, Satin



**Vickers**  
**QDI-5-903-01**  
Tendon Hooklet  
17 cm , Finish, Satin

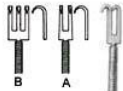

**Vickers**  
**QDI-5-904-02**  
Hooklet  
16 cm , Finish, Satin

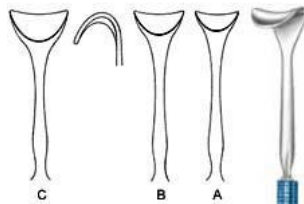

**Vickers**  
**QDI-5-905-12**  
Saddle Hook  
14 cm , Finish, Satin



**Graefe**  
**QDI-5-906-01**  
Micro Hooklet  
15 cm , Finish, Satin

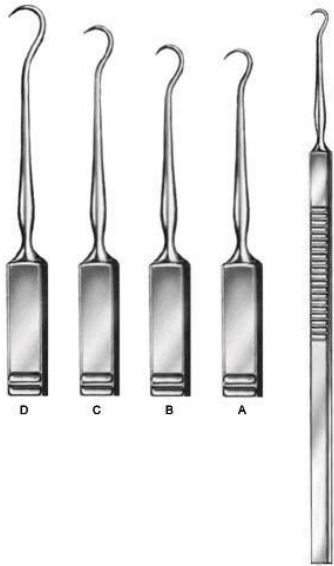

**Skin Hook**

**QDI-5-907-01**

Skin Hook

16 cm Fig. 1, 16 cm Fig. 2, 16 cm Fig. 3, 16 cm Fig. 4, Finish, Satin



**O Connor**

**QDI-5-908-16**

Skin Hook

16 cm, Finish, Satin

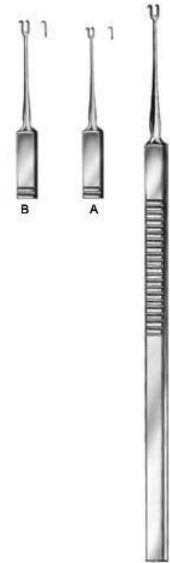

**Guthrie**

**QDI-5-909-01**

Skin Hook

15.5 cm, Finish, Satin

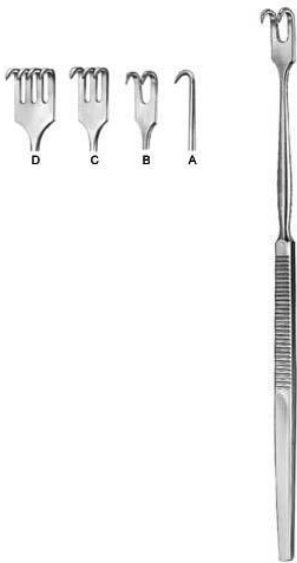

**Hooklet**

**QDI-5-910-01**

Hooklet

16.5 cm, Finish, Finish



**Hooklet**

**QDI-5-911-01**

Hooklet

16.5 cm, Finish, Satin



**Hooklet**

**QDI-5-912-02**

Hooklet

16 cm, Finish, Satin



**Hooklet**

**QDI-5-913-04**

Hooklet

16.5 cm, Finish, Satin



**Vessel Hook**

**QDI-5-914-12**

Vessel Hook

12 cm, Finish, Satin

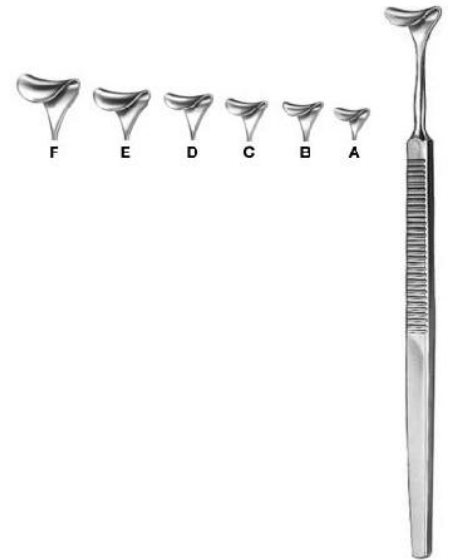

**Desmarres**

**QDI-5-915-08**

Saddle Hook

Finish, Satin, 16 cm 8 mm, 16 cm 10 mm, 16 cm 12 mm, 16 cm 14 mm, 16 cm 16 mm, 16 cm 18 mm

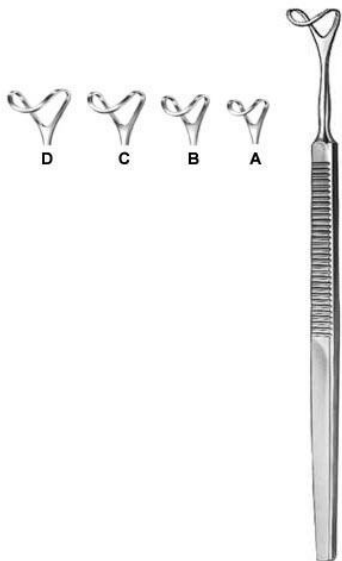

**Saddle Hook**

**QDI-5-916-12**

Saddle Hook

16 cm 12 mm, 16 cm 14 mm, 16 cm 16 mm, 16 cm 18 mm, Finish, Satin

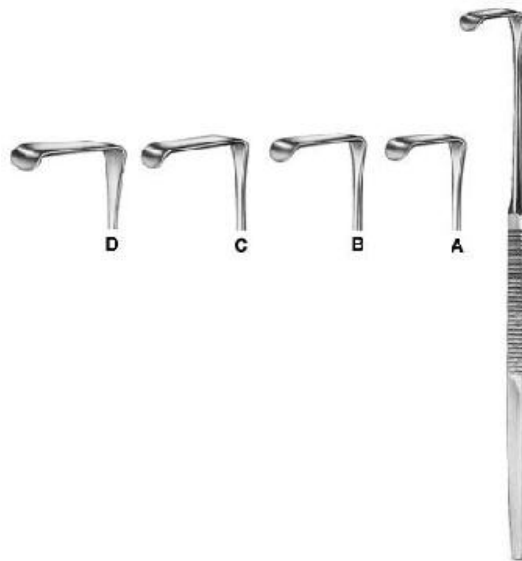

**Langenbeck-Mini**

**QDI-5-917-10**

Langenbeck-Mini

16 cm, Finish, Satin



**Hooklet**

**QDI-5-918-16**

Hooklet

16 cm 14 x 8, Finish, Satin





**Hooklet**

**QDI-5-919-01**

Hooklet  
16.5 cm, Finish, Satin



**Hooklet**

**QDI-5-920-01**

Hooklet  
16.5 cm, Finish, Satin



**Meyerding**

**QDI-5-921-01**

Hooklet  
17.5 cm Fig. 1, 17.5 cm Fig. 2, 17.5 cm Fig. 3, 17.5 cm Fig. 4, 17.5 cm Fig. 5, 17.5 cm Fig. 6, Finish, Satin



**Senn-Green**

**QDI-5-922-01**

Hooklet  
15 cm Fig. 1, 15 cm Fig. 2, Finish, Satin



**Ragnell-Davis**

**QDI-5-923-14**

Hooklet  
14 cm, Finish, Satin

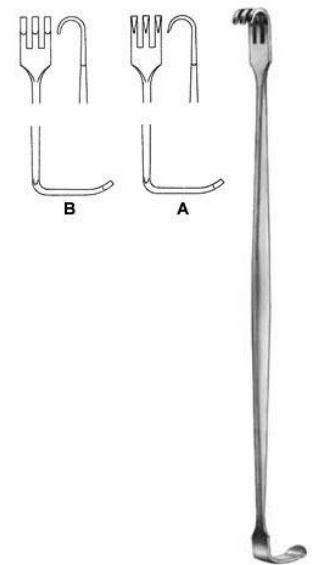

**Senn-Miller**

**QDI-5-924-16**

Hooklet  
16 cm, Finish, Satin



**Cushing**

**QDI-5-925-20**

Cushing  
20.5 cm, Finish, Satin



**Cushing**

**QDI-5-926-08**

Saddle Hook  
20.5 cm 8 mm wide, 20.5 cm 10 mm wide,  
Finish, Satin, 20.5 cm 12 mm wide, 20.5 cm 14  
mm wide, 20.5 cm 16 mm wide, 20.5 cm 18 mm  
wide

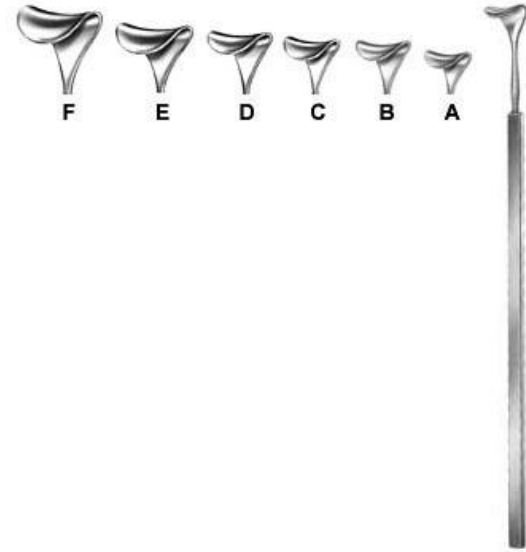

**Cushing**

**QDI-5-927-08**

Saddle Hook 8 mm to 18 mm wide  
24 cm, Finish, Satin



**Brom**

**QDI-5-928-01**

Vein Hook  
19.5 cm, Finish, Satin



**Strandell-Stillie**

**QDI-5-929-01**

Strandell-Stillie  
19 cm Fig. 1, 19 cm Fig. 2, Finish, Satin

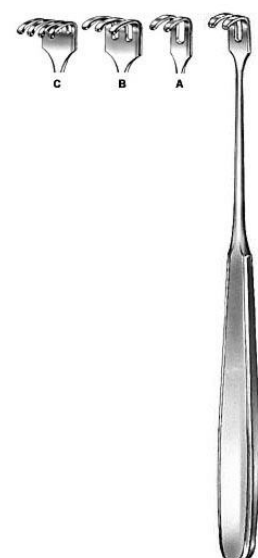

**Klapp**

**QDI-5-930-01**

Retractor 12 x 6, 12 x 11, 15 x 11  
17.5 cm, Finish, Satin



**Hooklet**  
**QDI-5-931-04**  
Hooklet  
16.5 cm, Finish, Satin

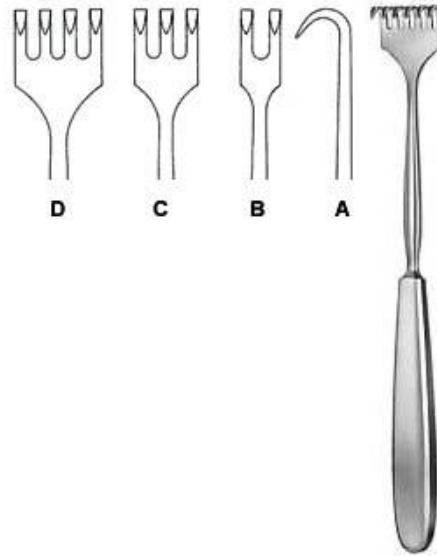

**Volkmann**  
**QDI-5-932-01**  
Retractor  
21.5 cm, Finish, Satin

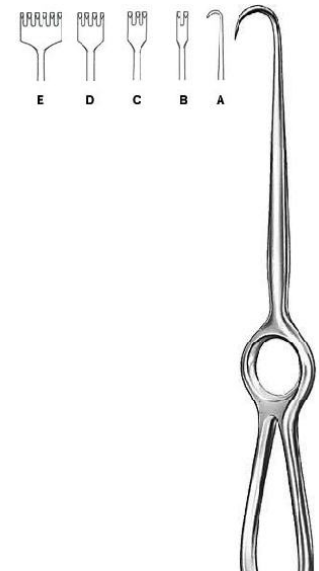

**Volkmann**  
**QDI-5-933-01**  
Retractor  
22 cm, 21.5 cm, Finish, Satin

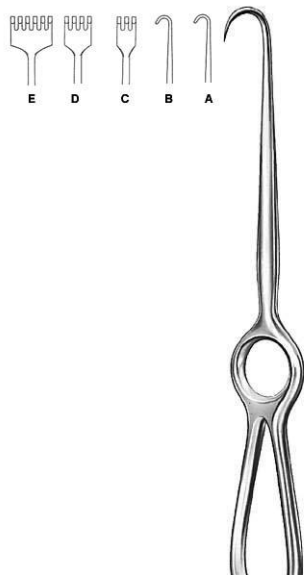

**Kocher**  
**QDI-5-934-01**  
Retractor  
22 cm, Finish, Satin

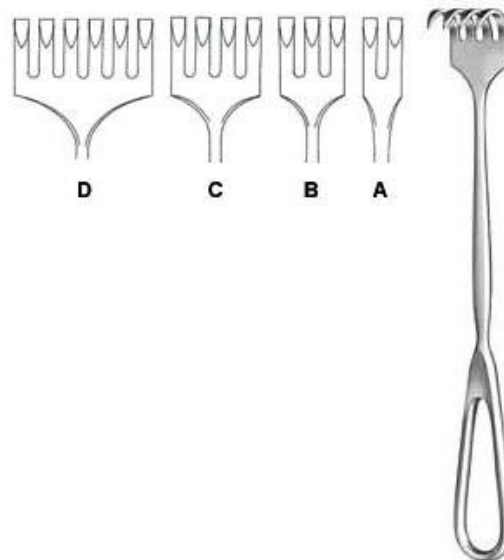

**Martin**  
**QDI-5-935-02**  
Retractor  
22.5 cm, Finish, Satin

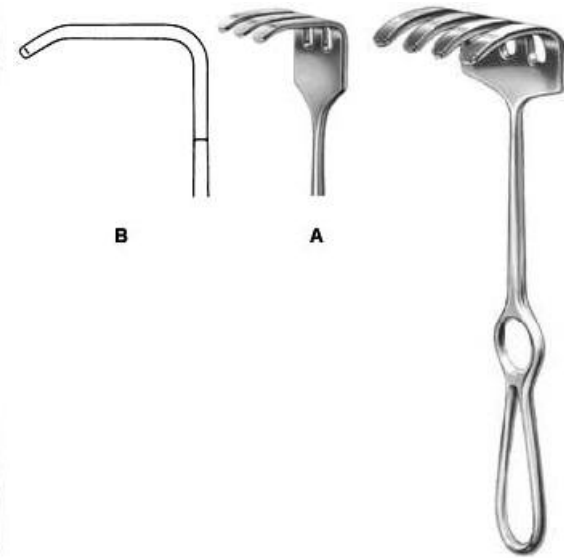

**Ollier**  
**QDI-5-936-03**  
Retractor  
23 cm 36 x 30, Finish, Satin, 23 cm 36 x 60

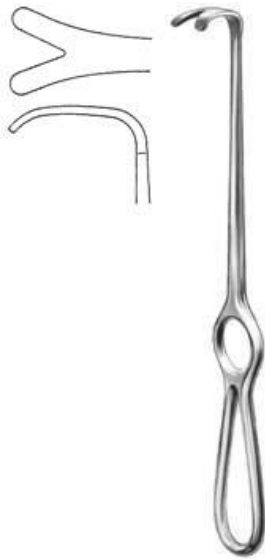

**Wassmund**

**QDI-5-937-02**

Retractor

20.5 cm 33 x 21, Finish, Satin

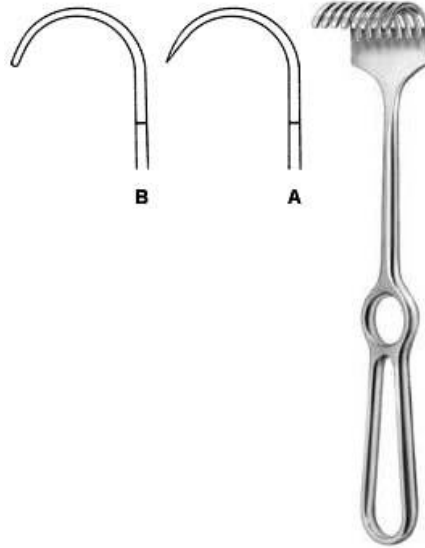

**Korte**

**QDI-5-938-08**

Retractor

24.5 cm 40 x 30, Finish, Satin

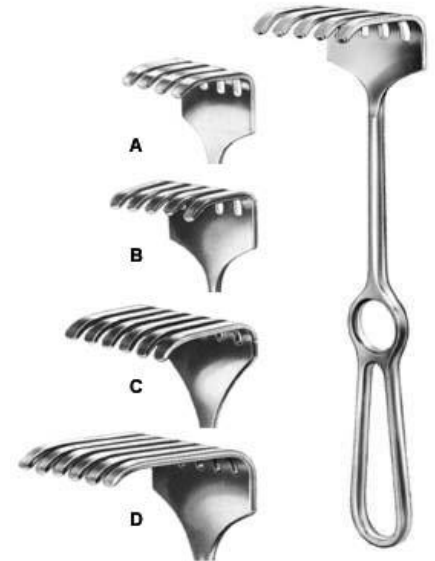

**Israel**

**QDI-5-939-04**

Retractor

25.5 cm, Finish, Satin

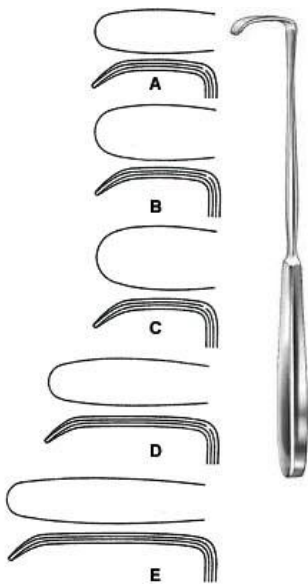

**Langenbeck**

**QDI-5-940-01**

Retractor

22.5 cm 30 x 11 mm, 22.5 cm 30 x 14 mm, 22.5 cm 30 x 16 mm, 22.5 cm 40 x 11 mm, 22.5 cm 50 x 11 mm, Finish, Satin

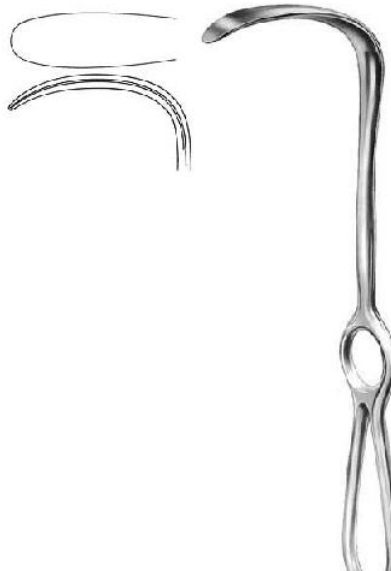

**Langenbeck**

**QDI-5-942-21**

Retractor

21 cm 65 x 20 mm, Finish, Satin

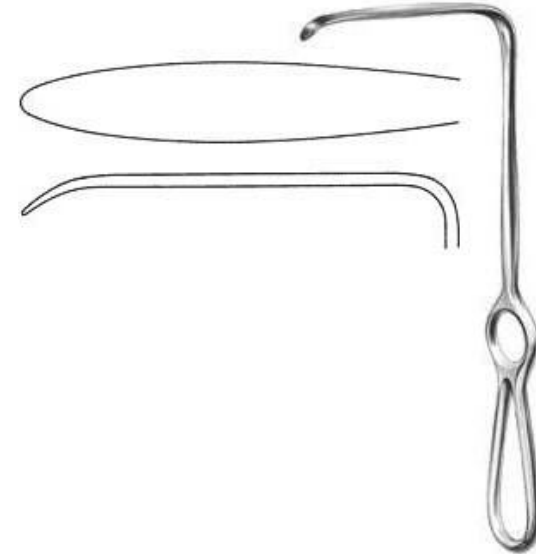

**Langenbeck**

**QDI-5-943-21**

Retractor

22.5 cm 85 x 15 mm, Finish, Satin



**Lahey**

**QDI-5-944-19**

Retractor

19.5 cm 36 x 19 mm, Finish, Satin



**Little**

**QDI-5-945-20**

Retractor

20 cm 13 x 15 mm, Finish, Satin

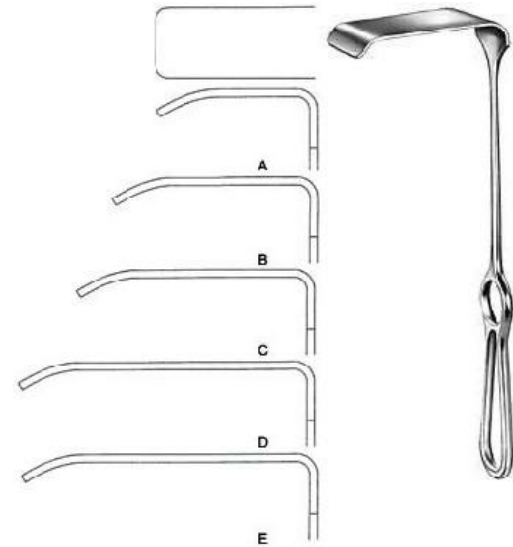

**Kocher**

**QDI-5-946-18**

Retractor

23 cm 43 x 18 mm, 23 cm 53 x 20 mm, 23 cm 63 x 25 mm, 23 cm 77 x 30 mm, 23 cm 78 x 40 mm, Finish, Satin

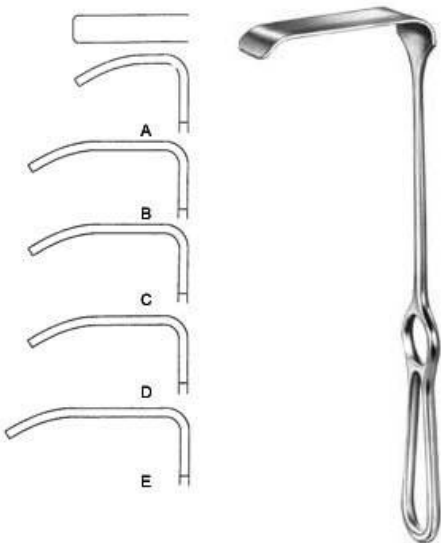

**Kocher-Langenbeck**

**QDI-5-947-01**

Retractor

21.5 cm 25 x 6 mm, 21.5 cm 35 x 8 mm, 21.5 cm 35 x 11 mm, 21.5 cm 35 x 15 mm, 21.5 cm 40 x 11 mm, 21.5 cm 55 x 11 mm, 21.5 cm 70 x 14 mm, 21.5 cm 80 x 12 mm, Finish, Satin

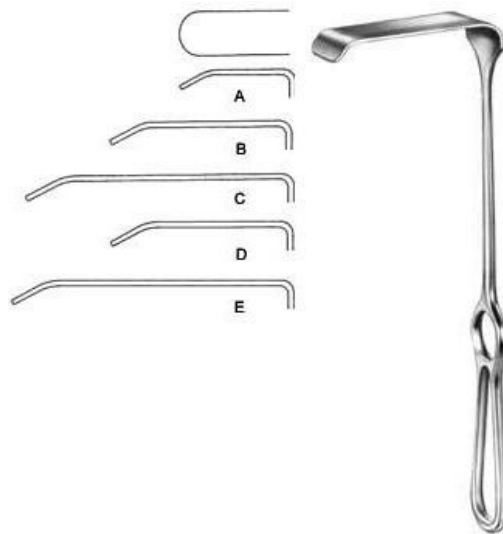

**Kocher-Langenbeck**

**QDI-5-948-01**

Retractor

21.5 cm 25 x 10 mm, 21.5 cm 40 x 13 mm, 21.5 cm 60 x 13 mm, 21.5 cm 40 x 18 mm, 21.5 cm 60 x 18 mm, 21.5 cm 85 x 18 mm, 21.5 cm 60 x 25 mm, 21.5 cm 85 x 25 mm, Finish, Satin

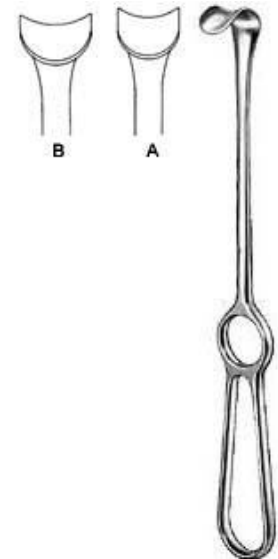

**Kocher**

**QDI-5-949-01**

Retractor

21.5 cm 22 x 12, 21.5 cm 24 x 14 mm, Finish, Satin

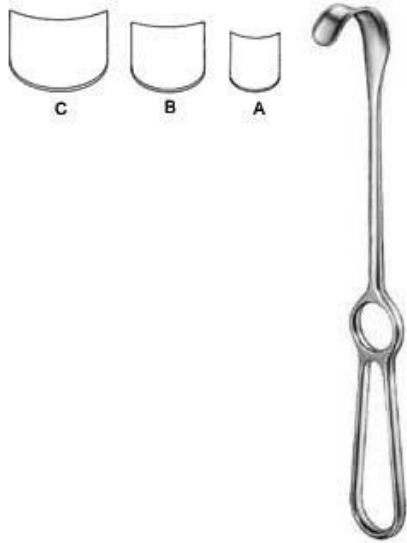

**Kocher**

**QDI-5-950-01**

Retractor

22 cm 42 x 10 mm, 22 cm 42 x 15 mm, 22 cm 43 x 20 mm, Finish, Satin

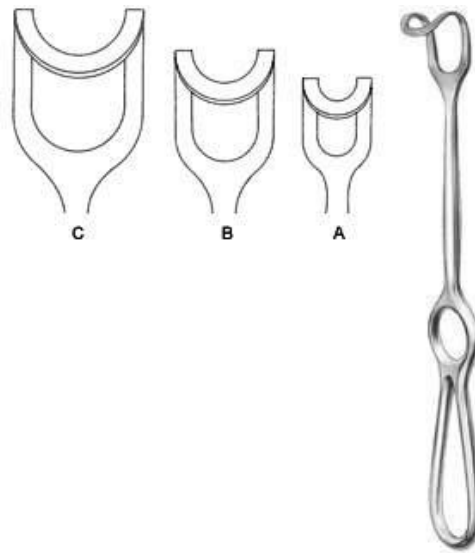

**Middeldorpf**

**QDI-5-951-01**

Retractor

21.5 cm 18 x 17 mm, 23 cm 25 x 22 mm, 24.5 cm 30 x 31 mm, Finish, Satin

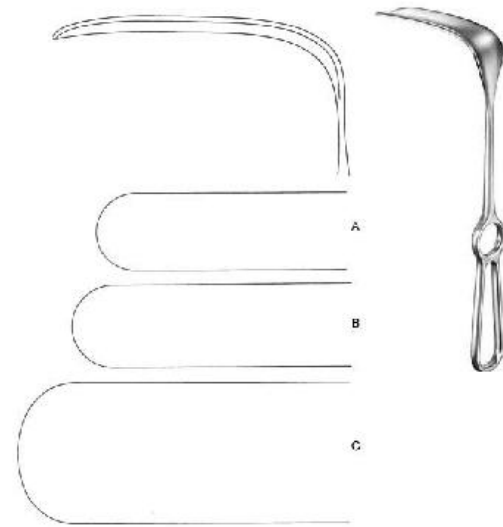

**Doyen-Stille**

**QDI-5-952-01**

Retractor

26 cm 97 x 29 mm, 26 cm 101 x 31 mm, 26 cm 127 x 52 mm, Finish, Satin



**Hosel**

**QDI-5-953-01**

Retractor

26 cm 63 x 21 mm, 26 cm 83 x 30 mm, 26 cm 103 x 30 mm, 26 cm 120 x 30 mm, 26 cm 140 x 30 mm, 26 cm 140 x 40 mm, Finish, Satin

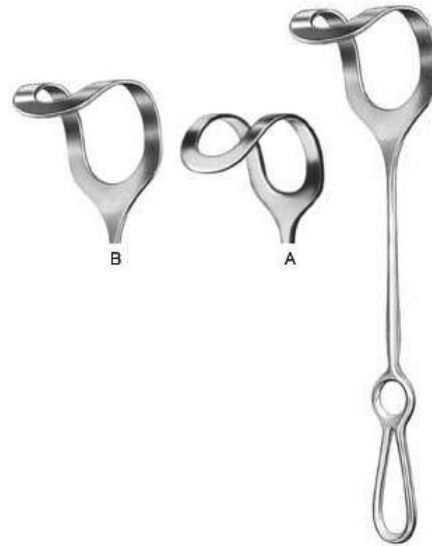

**Middeldorpf**

**QDI-5-954-01**

Retractor

27 cm 48 x 45 mm, 27 cm 52 x 50 mm, 27 cm 60 x 70 mm, Finish, Satin

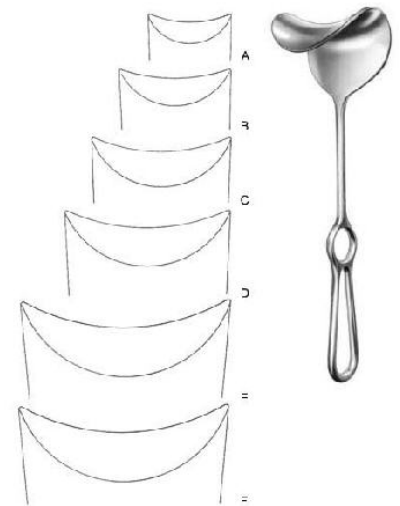

**Fritsch**

**QDI-5-955-01**

Retractor

23.5 cm 37 x 31 mm, 24 cm 38 x 40 mm, 25 cm 43 x 51 mm, 25 cm 49 x 61 mm, 25.5 cm 48 x 75 mm, 25.5 cm 65 x 85 mm, Finish, Satin



**Doyen**

**QDI-5-956-25**

Retractor

24 cm 48 x 88 mm, Finish, Satin



**Kocher**

**QDI-5-957-22**

Retractor

24 cm 73 x 25 mm, Finish, Satin



**Kocher**

**QDI-5-958-01**

Retractor

25 cm 80 x 45 mm, 25 cm 80 x 55 mm, 25 cm 80 x 65 mm, Finish, Satin



**Martin**

**QDI-5-959-25**

Retractor

26 cm 110 x 27 mm, Finish, Satin

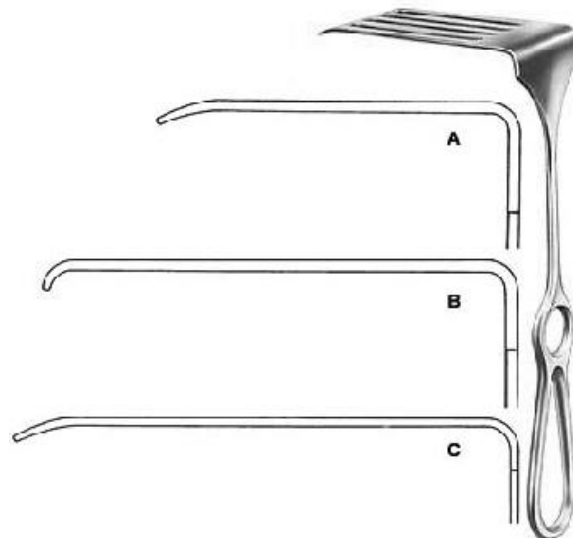

**Coryllos**

**QDI-5-960-01**

Retractor

24 cm 85 x 22 mm, 24 cm 108 x 43 mm, 24 cm 119 x 65 mm, Finish, Satin



**Davidson**

**QDI-5-961-01**

Retractor

19 cm 80 x 54 mm, 18.5 cm 80 x 95 mm, Finish, Satin

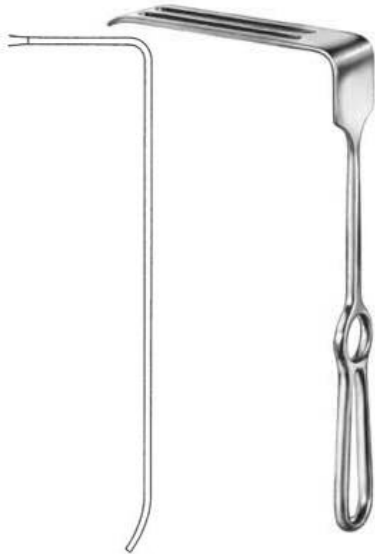

**Sauerbruch**

**QDI-5-962-25**

Retractor

25.5 cm 127 x 38 mm, Finish, Satin

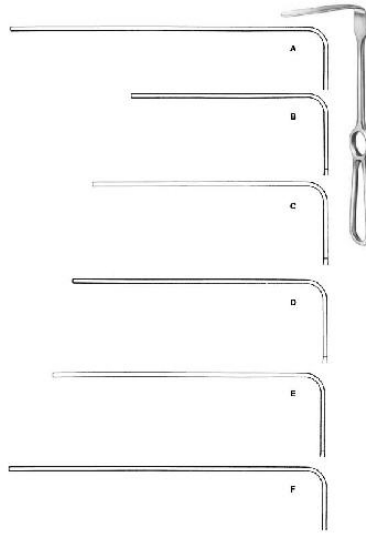

**Brunner**

**QDI-5-963-08**

Retractor

25.5 cm 84 x 20 mm, 25.5 cm 104 x 25 mm, 25.5 cm 124 x 30 mm, 25.5 cm 130 x 30 mm, 25.5 cm 144 x 30 mm, 25.5 cm 160 x 30 mm, 25.5 cm 164 x 30 mm, Finish, Satin

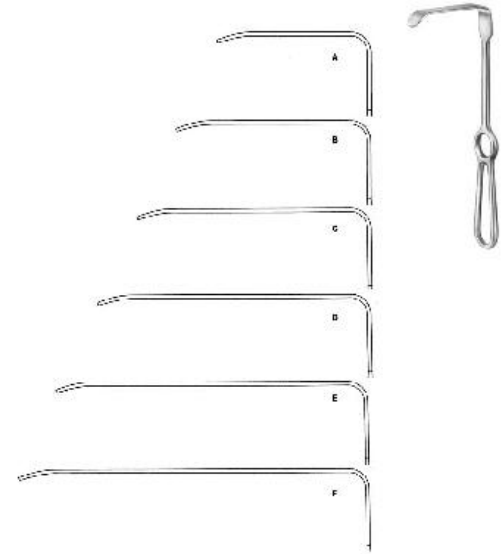

**Brunner**

**QDI-5-964-08**

Retractor

25.5 cm 82 x 20 mm, 25.5 cm 102 x 20 mm, 25.5 cm 122 x 25 mm, 25.5 cm 140 x 25 mm, 25.5 cm 162 x 30 mm, 25.5 cm 182 x 30 mm, Finish, Satin

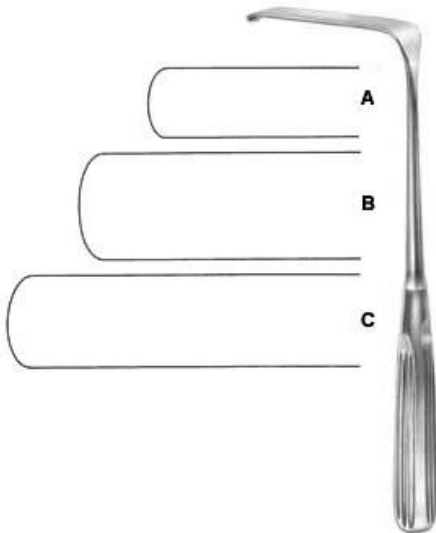

**Sauerbruch**

**QDI-5-965-01**

Retractor

22.5 cm 50 x 15 mm, 22.5 cm 63 x 23 mm, 22.5 cm 80 x 20 mm, Finish, Satin



**Deaver**

**QDI-5-966-01**

Retractor

18 cm 19 mm, Finish, Satin

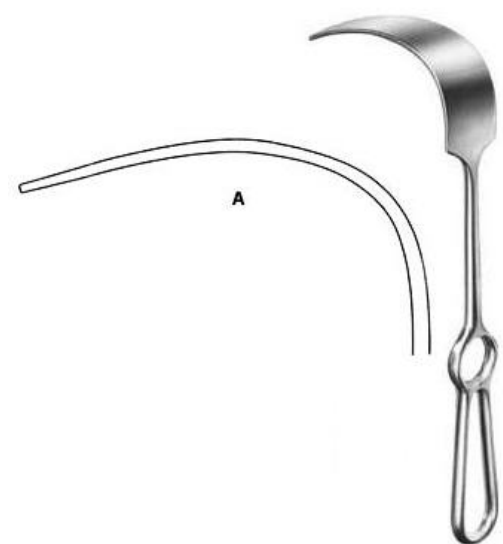

**Mikulicz**

**QDI-5-968-01**

Retractor

25 cm 90 x 35 mm, 25 cm 125 x 50 mm, 25 cm 160 x 50 mm, Finish, Satin





**Mikulicz**

**QDI-5-969-26**

Retractor

26 cm 90 x 55 mm, Finish, Satin

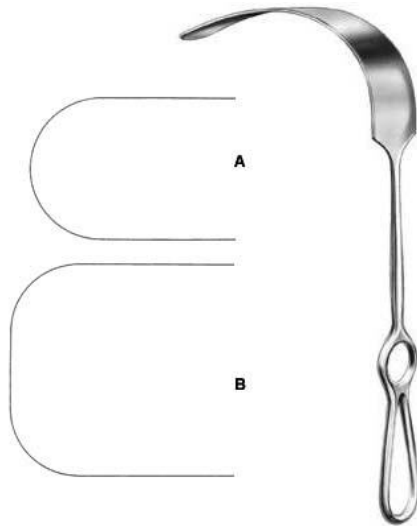

**Kelly**

**QDI-5-970-01**

Retractor

27.5 cm 205 x 38 mm, 27.5 cm 205 x 57 mm,  
Finish, Satin



**Farabeuf**

**QDI-5-971-00**

Retractor

15 cm Fig. 1 = 23 x 16, 15 cm Fig. 1 = 26 x 16, 15  
cm Fig. 2 = 27 x 16, 15 cm Fig. 2 = 30 x 16, Finish,  
Satin

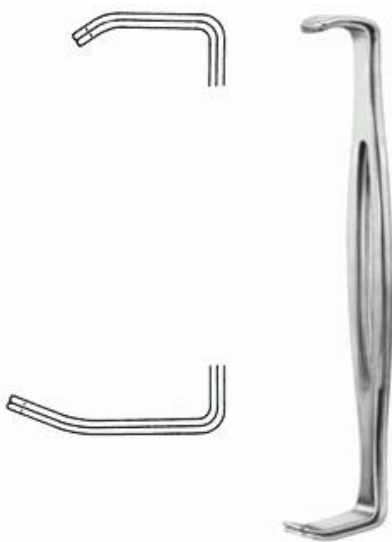

**Parker-Langenbeck**

**QDI-5-972-00**

Retractor

21.5 cm Fig. 1 = 21x15 mm, 21.5 cm Fig. 1 = 40x15  
mm, 21.5 cm Fig. 2 = 25x15 mm, 21.5 cm Fig. 2 =  
45x15 mm, Finish, Satin



**Alm**

**QDI-5-973-07**

Wound Spreaders, self-retaining

7 cm, Finish, Satin



**Alm**

**QDI-5-974-07**

Wound Spreaders, self-retaining

7 cm, Finish, Satin



**Gosset**

**QDI-5-975-22**

Abdominal Retractor  
18.5 cm , Finish, Satin



**Balfour-Baby**

**QDI-5-976-00**

Abdominal Retractor spreading 90mm, 1 central  
blade 24 x 20 mm  
12.5 cm, Finish, Satin



**Balfour**

**QDI-5-977-00**

Abdominal retractor spreading 180 mm, lateral  
blades 70 x 35 mm, 1 central blade  
20 cm, Finish, Satin

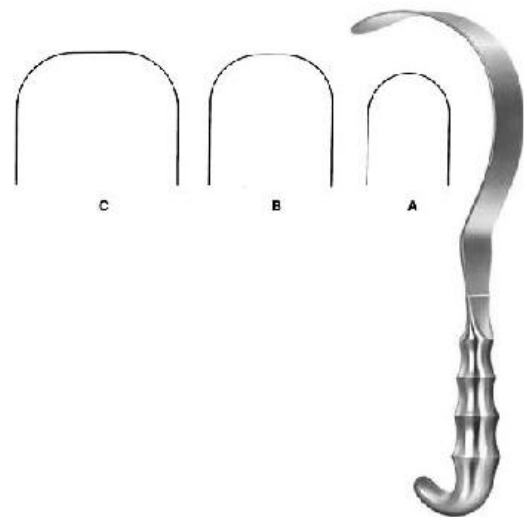

**Deaver**

**QDI-5-967-04**

Retractor

31.5 cm 25 mm, 31.5 cm 38 mm, 31.5 cm 50 mm,  
31.5 cm 100 mm, Finish, Satin



**Probe**

**QDI-5-1001-11**

Probe

11.5cm, 13 cm , 14.5 cm , 16 cm, 18 cm, 20cm, 25 cm , 30 cm, Finish, Satin



**Probe**

**QDI-5-1002-11**

Probe

11.5 cm, 13 cm , 14.5 cm , 16 cm, 18 cm, 20cm, 25 cm , 30 cm, Finish, Satin



**Probe**

**QDI-5-1003-13**

Probe

13 cm , 14.5 cm , 16 cm, 18 cm, 20 cm, 25 cm , Finish, Satin



**Probe With Eye**

**QDI-5-1004-13**

Probe with eye

13 cm , 14.5 cm , 16 cm, Finish, Satin

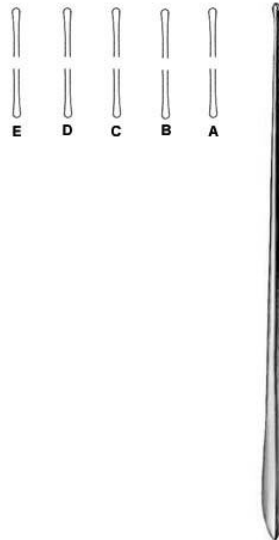

**Myrtle Leaf Probe**

**QDI-5-1006-13**

Myrtle Leaf Probe

13 cm , 14.5 cm , 16 cm, 18 cm, 20 cm, Finish, Satin



**Grooved Director**

**QDI-5-1007-13**

Grooved Director

13 cm , 14 cm, 16 cm, Finish, Satin



**Grooved Director**

**QDI-5-1008-13**

Grooved Director

13 cm , 14.5 cm , 16 cm, Finish, Satin



**Doyen**

**QDI-5-1009-14**

Grooved Director

14.5 cm , Finish, Satin



**Nelaton**

**QDI-5-1010-16**

Grooved Director

16 cm, Finish, Satin

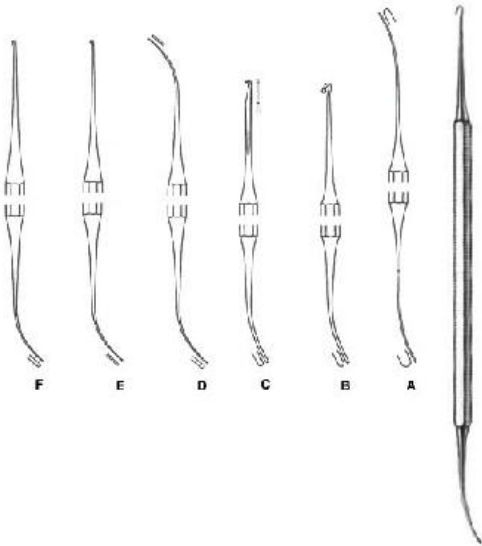

**Varady**

**QDI-5-1011-01**

Phlebotomizer

18 cm, 17.5 cm, Finish, Satin

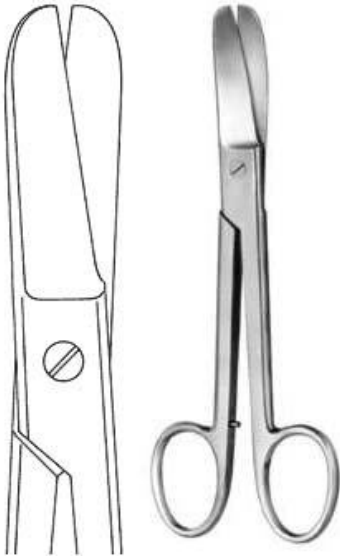

**Lorenz**

**QDI-6-101-23**

Bandage Scissors heavy pattern  
23 cm , Finish, Satin

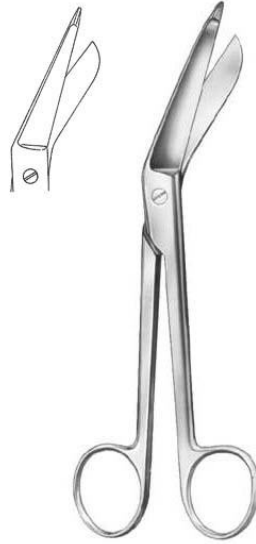

**Lister**

**QDI-6-102-14**

Bandage Scissors  
14.5 cm , 18.5 cm , 20 cm, Finish, Satin



**Bergmann**

**QDI-6-103-23**

Plaster Shears  
23.5 cm, Finish, Satin



**Esmarch**

**QDI-6-104-20**

Plaster Shears heavy pattern, short blades  
20 cm, Finish, Satin



**Bandage Scissors Black Plastic Ring  
With Autodavable**

**QDI-6-105-15**

Bandage Scissors black plastic ring with  
autodavable  
16 cm, 19 cm , Finish, Satin



**Bandage Scissors Black Plastic Rings**

**QDI-6-106-18**

Bandage Scissors black plastic rings  
16 cm, 19 cm , Finish, Satin

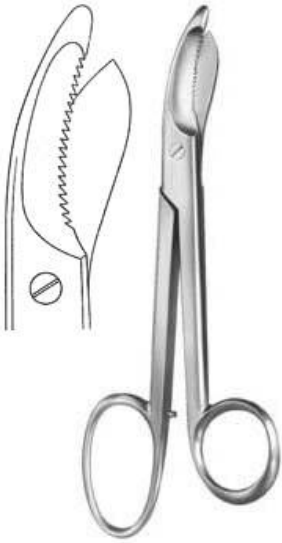

**Bruns**

**QDI-6-107-24**

Plaster Scissors  
24 cm , Finish, Satin



**Stille-Martin**

**QDI-6-108-23**

Plaster Shears  
23 cm , 27 cm, 38 cm, Finish, Satin

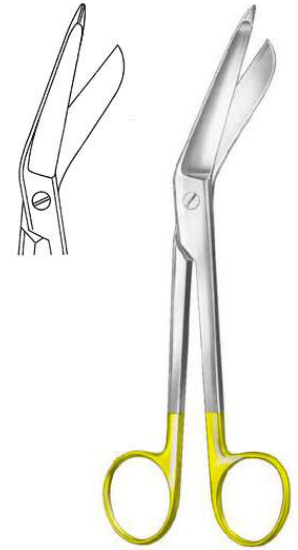

**Lister**

**QDI-6-109-18**

Bandage Scissors  
18 cm, Finish, Satin



**Bruns**

**QDI-6-110-24**

Plaster Scissors  
24 cm , Finish, Satin



**Hopkins**

**QDI-6-111-20**

Plaster Knife with wooden handle  
20 cm, Finish, Satin



**Reiner**

**QDI-6-112-18**

Plaster Knife  
18 cm, Finish, Satin



**Reiner**

**QDI-6-113-18**  
Plaster Knife  
18 cm, Finish, Satin



**Martin**

**QDI-6-114-21**  
Plaster Knife with wooden handle  
21 cm, Finish, Satin



**Engel**

**QDI-6-115-14**  
Plaster Saw  
15.5 cm, Finish, Satin

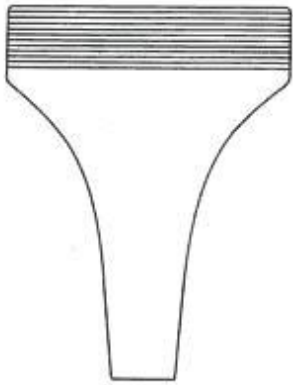

**Hennig**

**QDI-6-116-28**  
Plaster Spreader  
28 cm, Finish, Satin



**Wolff**

**QDI-6-117-18**  
Plaster Breaker  
18 cm, 26.5 cm, Finish, Satin





**Bone Shear**

**QDI-9-101-23**

Bone Shear  
Finish, Satin, 23 cm



**Rib Shear**

**QDI-9-102-22**

Rib Shear  
Finish, Satin, 23 cm



**Gluck**

**QDI-9-103-22**

Rib Shears  
Finish, Satin, 21 cm



**Giertz-Stille**

**QDI-9-104-27**

Rib Shear  
Finish, Satin, 24.5 cm



**Lebsche**

**QDI-9-105-24**

Sternum Chisel  
Finish, Satin, 24.5 cm



**Rib Retractor**

**QDI-9-106-01**

Rib Retractor lateral blades 12 x 16 mm spreading 95 mm  
Finish, Satin, Size 1





**Finochietto, Infant**

**QDI-9-107-01**

Rib Retractor lateral blades 15 x 15 mm spreading 75 mm

Finish, Satin, Size 1



**Finochietto, Baby**

**QDI-9-108-01**

Rib Retractor lateral blades 31 x 31 mm spreading 100 mm

Finish, Satin, Size 1



**Finochietto**

**QDI-9-109-01**

Rib Retractor lateral blades 40 x 45 mm spreading 135 mm

Finish, Satin, Size 1



**Burford**

**QDI-9-110-01**

Rib Retractor with two pairs of blades 47 x 62 mm + 65 x 62 mm, spreading 200 mm

Finish, Satin, Size 1



**Castaneda**

**QDI-9-111-01**

Rib Retractor lateral blades 10,5 x 32 mm spreading 65 mm

Finish, Satin, Size 1



**Finochietto (Modif.)**

**QDI-9-112-01**

Rib Retractor lateral blades 14 x 15 mm spreading 120 mm

Finish, Satin, Size 1



**Haight**

**QDI-9-113-90**

Rib Retractor lateral blades 30 x 30 mm spreading 120 mm  
Finish, Satin, Size 1



**Morse-Favaloro**

**QDI-9-114-01**

Sternal Retractor 4 movable blades 17 x 22 mm spreading 160 mm Sternal Retractor  
Finish, Satin, Size 1



**Morse**

**QDI-9-115-00**

Sternal Retractor 4 movable blades 22 x 27 mm spreading 200 mm  
Finish, Satin, Size 1



**Tuffier**

**QDI-9-116-02**

Rib Retractor lateral blades 22 x 27 mm spreading 200 mm  
Finish, Satin, Size 1

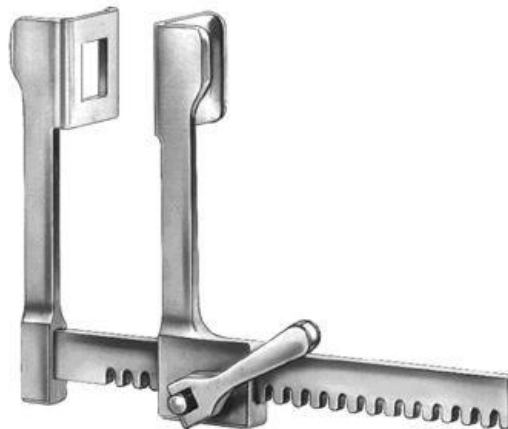

**Finochietto, Baby**

**QDI-9-117-75**

Rib Retractor lateral blades 14 x 15 mm spreading 75 mm  
Finish, Satin, Size 1



**Finochietto**

**QDI-9-118-01**

Rib Retractor lateral blades 30 x 45 mm spreading 150 mm  
Finish, Satin, Size 1



**DeBakey**

**QDI-9-119-00**

Rib Retractor spreading 150 mm  
Finish, Satin, Size 1



**DeBakey**

**QDI-9-120-00**

Rib Retractor spreading 200 mm  
Finish, Satin, Size 1



**Thoracic Retractor**

**QDI-9-121-00**

Thoracic Retractor  
Finish, Satin, Size 1



**Sellors**

**QDI-9-121-00**

Rib Contractor  
Finish, Satin, 20 cm



**Bailey-Baby**

**QDI-9-123-14**

Rib Contractor  
Finish, Satin, 15.5 cm



**Bailey**

**QDI-9-124-16**

Rib Contractor  
Finish, Satin, 20 cm



**Bailey-Gibbon**  
**QDI-9-125-16**  
Rib Contractor  
Finish, Satin, 20 cm



**Allison**  
**QDI-9-126-30**  
Lung Spatula  
Finish, Satin, 29.5 cm, 32.5 cm



**Price-Thomas**  
**QDI-9-127-22**  
Bronchus Clamp  
Finish, Satin, 22 cm

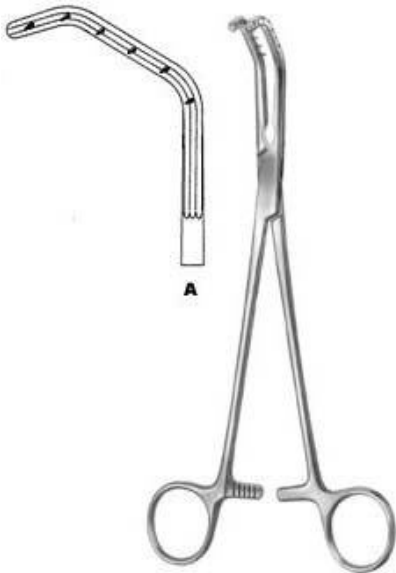

**Price-Thomas**  
**QDI-9-128-22**  
Bronchus Clamp  
Finish, Satin, 22 cm

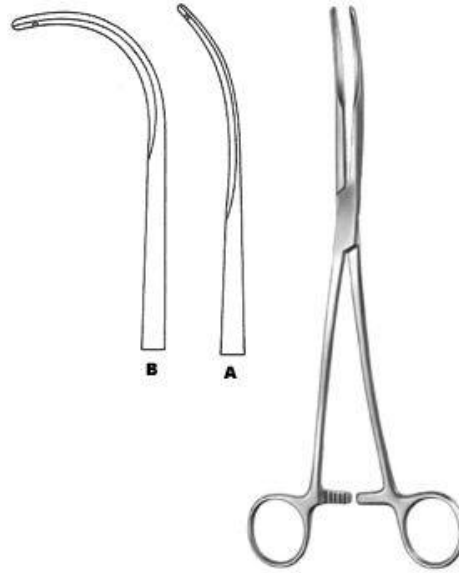

**Semb**  
**QDI-9-129-24**  
Bronchus Clamp  
Finish, Satin, 24.5 cm



**Lovlace**  
**QDI-9-130-20**  
Lung Grasping Forceps  
Finish, Satin, 20.5 cm

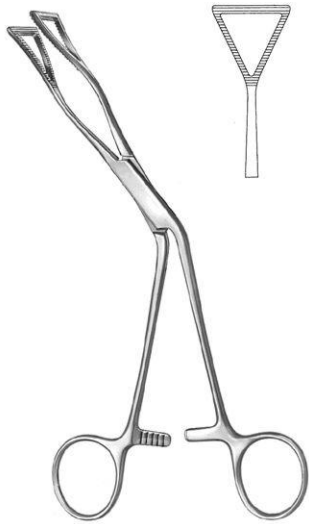

**Lovelace**

**QDI-9-131-20**

Lung Grasping Forceps  
Finish, Satin, 19 cm



**DeBakey-Satinsky**

**QDI-9-132-07**

Bulldog Clamp  
Finish, Satin, 7", 9 cm



**Glover**

**QDI-9-133-06**

Bulldog Clamp  
Finish, Satin, 6 cm



**Santulli**

**QDI-9-134-07**

Bulldog Clamp  
Finish, Satin, 7



**Gregory, Soft**

**QDI-9-135-09**

Bulldog Clamp  
Finish, Satin, 9 cm, 11 cm



**Gregory**

**QDI-9-136-01**

Bulldog Clamp  
Finish, Satin, 10.5 cm

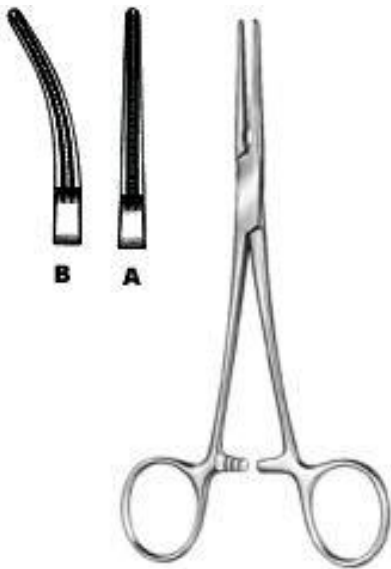

**DeBakey-Rankin**

**QDI-9-137-16**

Haemostatic Forceps  
Finish, Satin, 16 cm

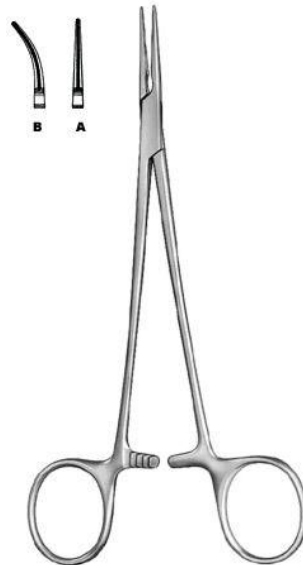

**DeBakey-Mosquito**

**QDI-9-138-15**

Haemostatic Forceps  
Finish, Satin, 15 cm



**Ochsner**

**QDI-9-139-23**

Aortic Clamp  
Finish, Satin, 23.5 cm



**Diethrich**

**QDI-9-140-21**

Aortic Clamp  
Finish, Satin, 22 cm

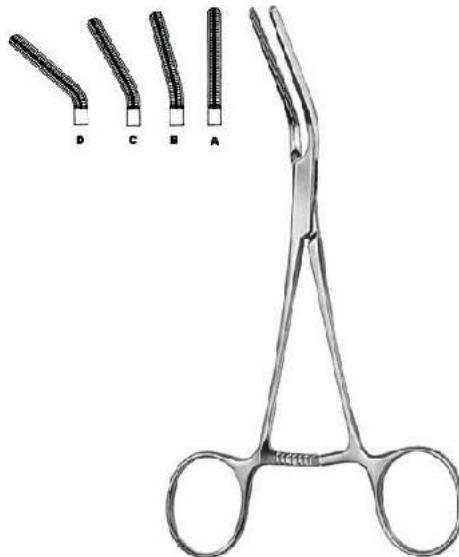

**Dardik**

**QDI-9-141-00**

Multi purpose Vascular Clamp  
Finish, Satin, 15 cm



**Dale**

**QDI-9-142-18**

Peripheral Vascular Clamp  
Finish, Satin, 18 cm

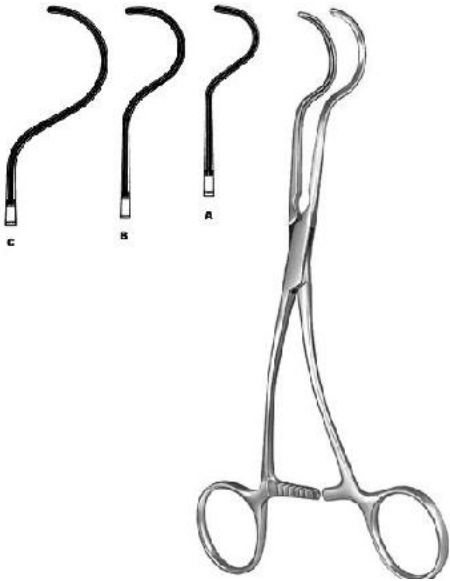

**Dale**

**QDI-9-143-17**

Peripheral Vascular Clamp  
Finish, Satin, 17.5 cm

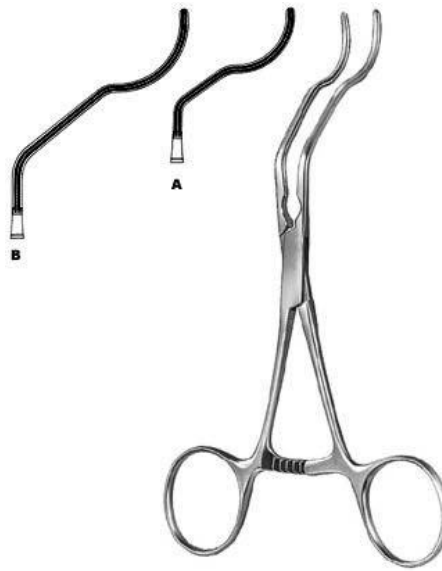

**Gregory**

**QDI-9-144-14**

Profunda Clamp  
Finish, Satin, 13 cm , 16 cm, 18 cm

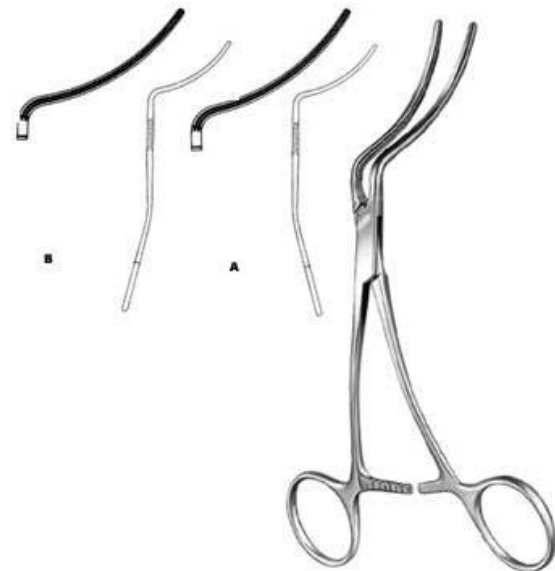

**Martin**

**QDI-9-145-16**

Peripheral Vascular Clamp  
Finish, Satin, 16.5 cm



**Husfeldt**

**QDI-9-146-18**

Peripheral Vascular Clamp  
Finish, Satin, 17.5 cm



**Husfeldt**

**QDI-9-147-18**

Peripheral Vascular Clamp  
Finish, Satin, 18 cm



**Husfeldt**

**QDI-9-148-17**

Peripheral Vascular Clamp  
17 cm , Finish, Satin



**DeBakey**  
**QDI-9-149-16**  
Vascular Forceps  
Finish, Satin, 16 cm



**DeBakey**  
**QDI-9-150-16**  
Vascular Forceps  
Finish, Satin, 16 cm



**DeBakey**  
**QDI-9-151-16**  
Vascular Forceps  
Finish, Satin, 16 cm



**DeBakey**  
**QDI-9-152-16**  
Vascular Forceps  
Finish, Satin, 16 cm



**DeBakey**  
**QDI-9-153-16**  
Vascular Forceps  
Finish, Satin, 16 cm



**DeBakey**  
**QDI-9-154-07**  
Bulldog Clamp  
Finish, Satin, 7





**DeBakey**

**QDI-9-155-07**

Bulldog Clamp  
Finish, Satin, 7



**Applying Forceps**

**QDI-9-156-23**

Applying Forceps  
Finish, Satin, 23.5 cm

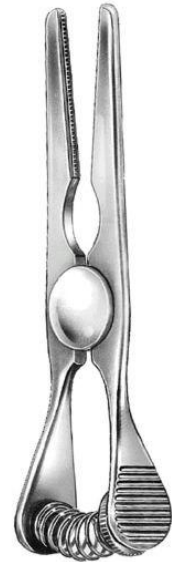

**Glover**

**QDI-9-157-06**

Bulldog Clamp  
Finish, Satin, 7



**Glover**

**QDI-9-158-06**

Bulldog Clamp  
Finish, Satin, 6.5 cm

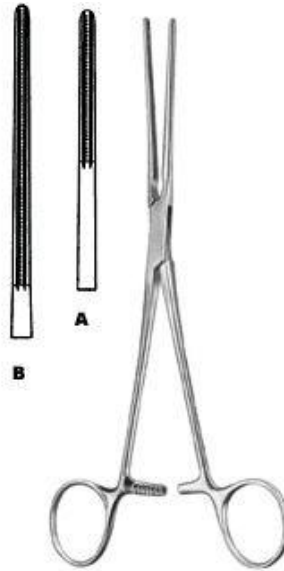

**Potts**

**QDI-9-159-21**

Coarctation Clamp  
Finish, Satin, 21 cm

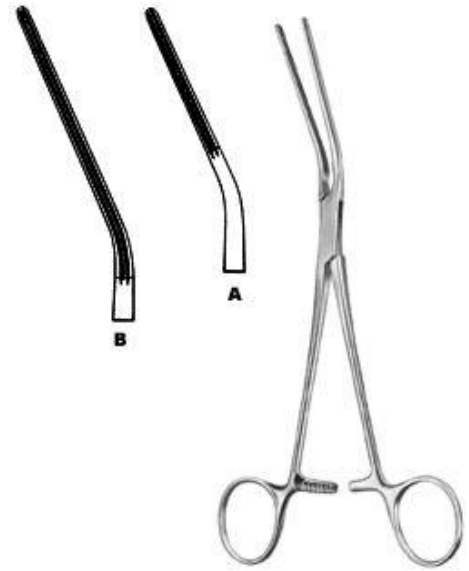

**Potts**

**QDI-9-160-21**

Coarctation Clamp  
Finish, Satin, 20.5 cm

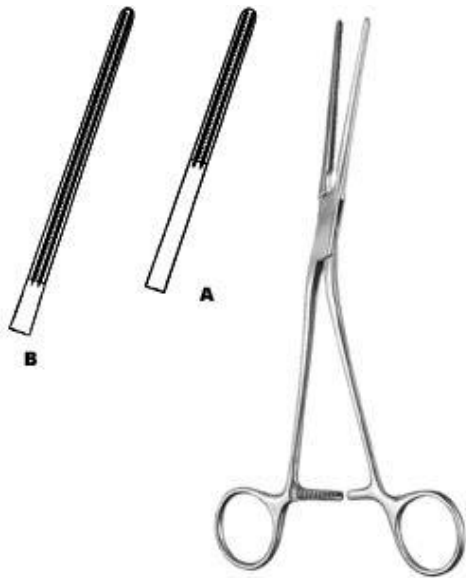

**Potts**

**QDI-9-161-21**

Coarctation Clamp  
Finish, Satin, 20.5 cm



**Potts**

**QDI-9-162-22**

Anastomosis Clamp  
Finish, Satin, 21.5 cm



**Potts**

**QDI-9-163-22**

Anastomosis Clamp  
Finish, Satin, 22 cm

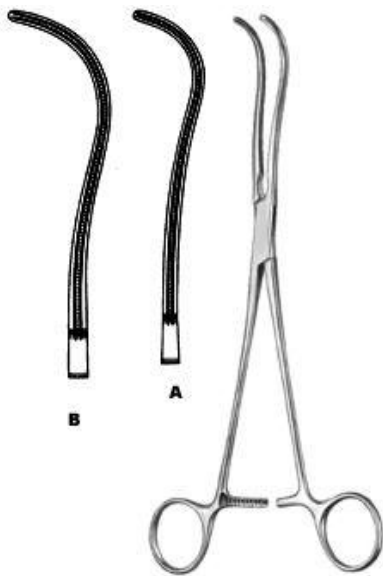

**DeBakey**

**QDI-9-164-19**

Ligature Forceps  
Finish, Satin, 19 cm



**DeBakey**

**QDI-9-165-16**

Peripheral Vascular Clamp  
Finish, Satin, 16 cm



**DeBakey**

**QDI-9-166-19**

Peripheral Vascular Clamp  
Finish, Satin, 16 cm

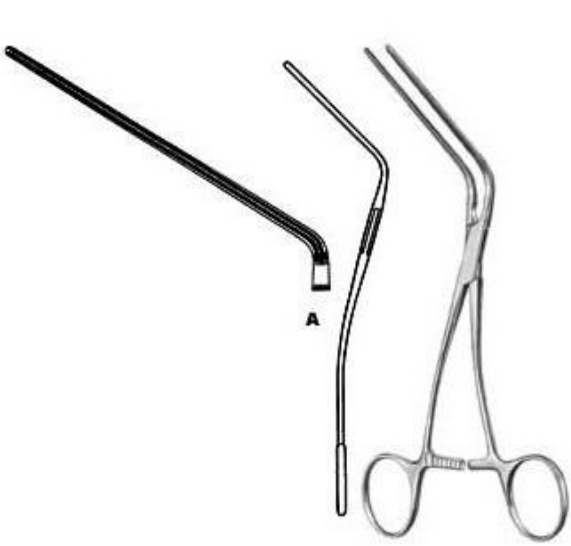

**Leland-Jones**

**QDI-9-167-18**

Peripheral Vascular Clamp  
Finish, Satin, 18 cm

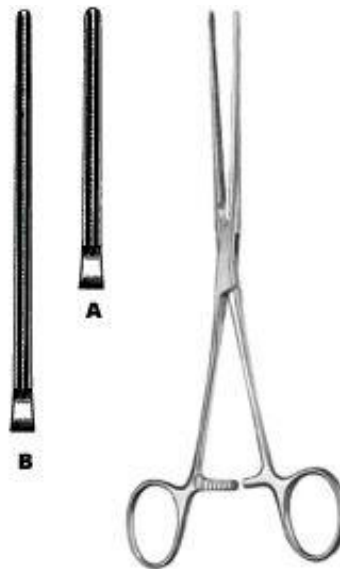

**Bainbridge**

**QDI-9-168-15**

Multi purpose Vascular Clamp  
Finish, Satin, 15 cm



**Bainbridge**

**QDI-9-169-15**

Multi purpose Vascular Clamp  
Finish, Satin, 15 cm

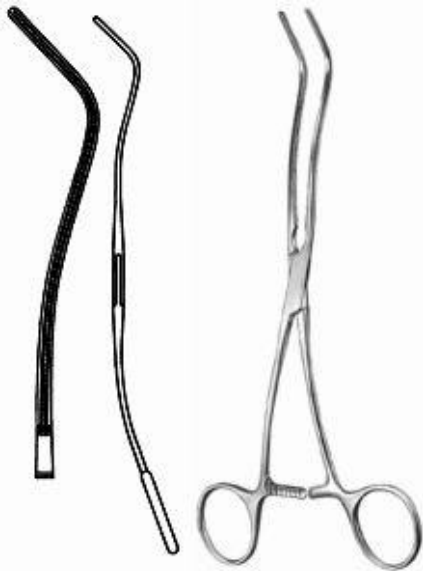

**DeBakey**

**QDI-9-170-20**

Multi purpose Vascular Clamp  
Finish, Satin, 20 cm



**DeBakey**

**QDI-9-171-26**

Aortic Aneurysm Clamp  
Finish, Satin, 26 cm



**DeBakey**

**QDI-9-172-28**

Aortic Aneurysm Clamp  
Finish, Satin, 28 cm



**DeBakey**

**QDI-9-173-30**

Aortic Aneurysm Clamp  
Finish, Satin, 30 cm



**DeBakey**

**QDI-9-174-27**

Aortic Clamp  
Finish, Satin, 27 cm

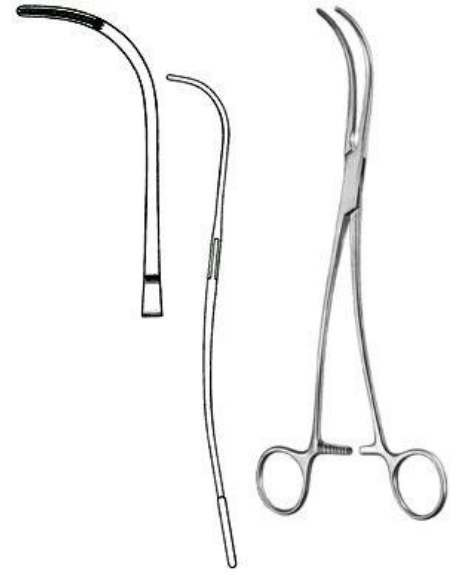

**DeBakey**

**QDI-9-175-24**

Ligature Forceps  
Finish, Satin, 24.5 cm



**DeBakey**

**QDI-9-176-24**

Ligature Forceps  
Finish, Satin, 24.5 cm

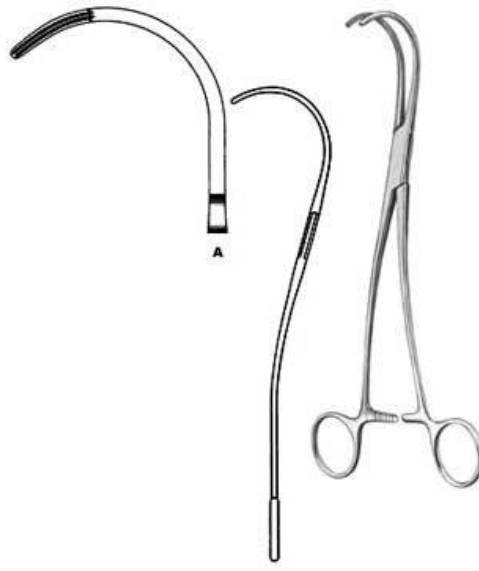

**DeBakey**

**QDI-9-178-25**

Ligature Forceps  
Finish, Satin, 27 cm

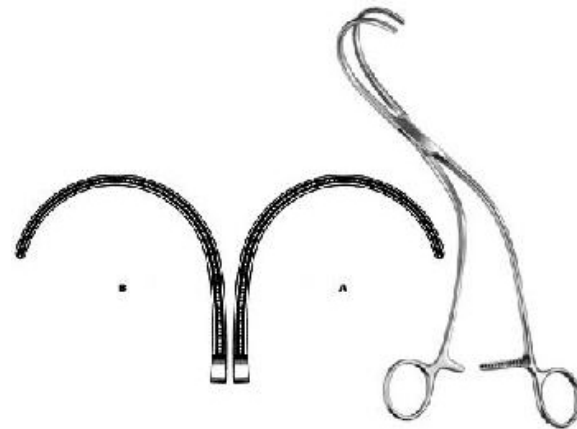

**Weber**

**QDI-9-179-01**

Aortic Clamp  
Finish, Satin, 24 cm



**Satinsky**

**QDI-9-180-20**

Tangential Occlusion Clamp  
Finish, Satin, 22 cm



**Harken**

**QDI-9-181-01**

Auricle Clamp  
Finish, Satin, 24.5 cm



**Lees**

**QDI-9-182-23**

Bronchus Clamp  
Finish, Satin, 23 cm



**Lees**

**QDI-9-183-25**

Bronchus Clamp  
Finish, Satin, 25 cm



**Lambert-Kay**

**QDI-9-184-21**

Anastomosis Clamp  
Finish, Satin, 22.5 cm



**DeBakey**

**QDI-9-185-17**

Anastomosis Clamp  
Finish, Satin, 16.5 cm



**Morris-DeBakey**

**QDI-9-186-18**

Aortic Clamp

Finish, Satin, 16.5 cm



**DeBakey-Bahnson**

**QDI-9-187-23**

Aneurysm Clamp

Finish, Satin, 23.5 cm

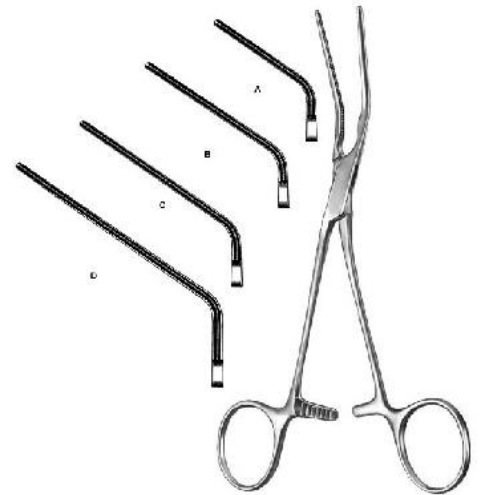

**DeBakey**

**QDI-9-188-20**

Multi purpose Vascular Clamp

Finish, Satin, 18 cm

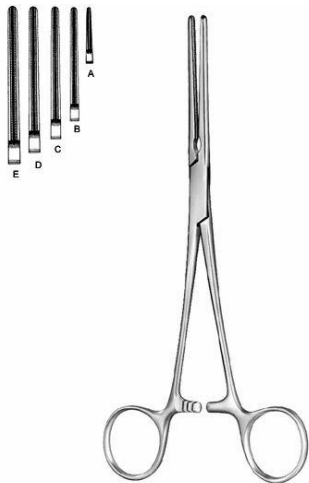

**DeBakey-Mosquito**

**QDI-9-189-12**

Haemostatic Forceps

Finish, Satin, 12.5 cm



**DeBakey-Mosquito**

**QDI-9-190-12**

Haemostatic Forceps

Finish, Satin, 12.5 cm



**DeBakey**

**QDI-9-191-17**

Multi purpose Vascular Clamp

Finish, Satin, 17 cm



**DeBakey**

**QDI-9-192-16**

Multi purpose Vascular Clamp  
Finish, Satin, 16.5 cm

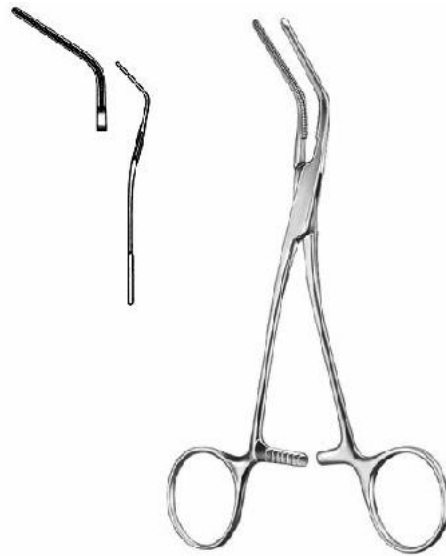

**DeBakey**

**QDI-9-193-15**

Multi purpose Vascular Clamp  
Finish, Satin, 16 cm

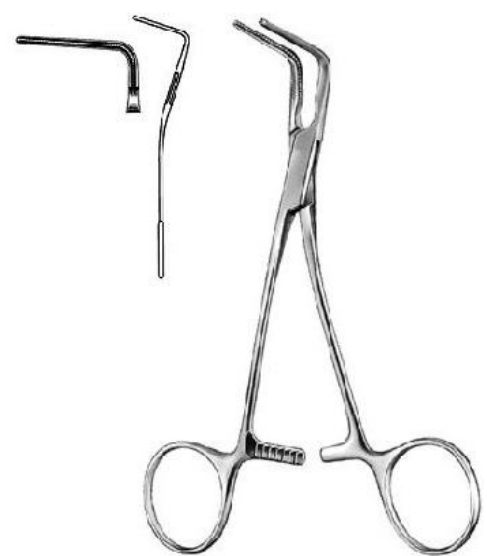

**DeBakey**

**QDI-9-194-15**

Multi purpose Vascular Clamp  
Finish, Satin, 16.5 cm



**DeBakey**

**QDI-9-195-17**

Multi purpose Vascular Clamp  
Finish, Satin, 16.5 cm



**Glover**

**QDI-9-196-17**

Multi purpose Vascular Clamp  
Finish, Satin, 17 cm



**Glover**

**QDI-9-197-17**

Multi purpose Vascular Clamp  
Finish, Satin, 17.5 cm

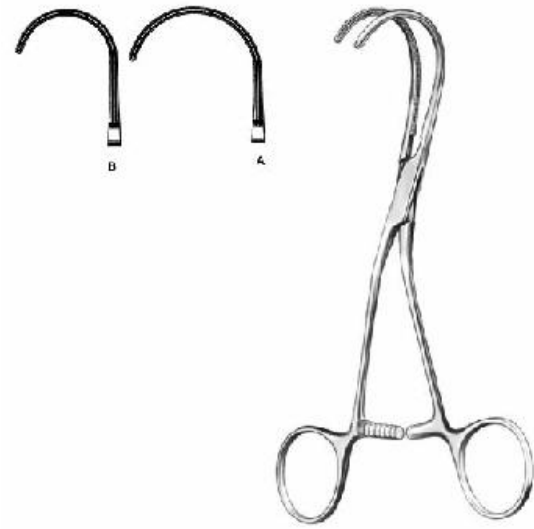

**DeBakey**

**QDI-9-198-16**

Multi purpose Vascular Clamp  
Finish, Satin, 16.5 cm

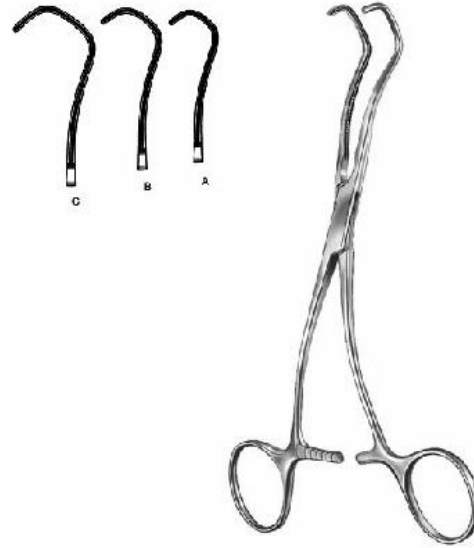

**Derra**

**QDI-9-199-16**

Anastomosis Clamp  
Finish, Satin, 16 cm Fig. 1, 17.5 cm Fig. 3, 18.5 cm  
Fig. 3



**DeBakey-Beck**

**QDI-9-200-17**

Anastomosis Clamp  
Finish, Satin, 17 cm



**Cooley**

**QDI-9-201-16**

Vascular Forceps  
Finish, Satin, 16 cm

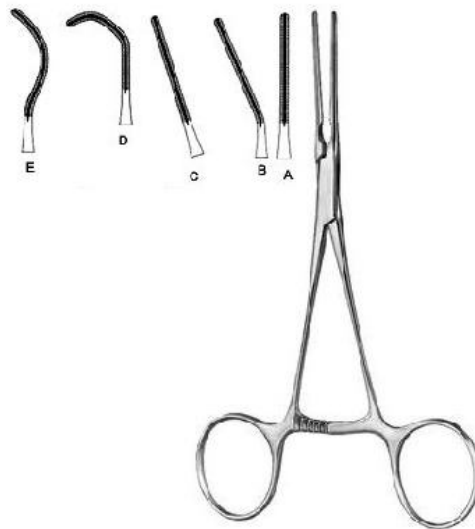

**Cooley**

**QDI-9-202-01**

Pediatric Vascular Clamp  
Finish, Satin, 14.5 cm



**Cooley**

**QDI-9-203-21**

Iliac Clamp  
Finish, Satin, 22 cm





**Cooley**  
**QDI-9-204-17**  
Anastomosis Clamp  
Finish, Satin, 17 cm

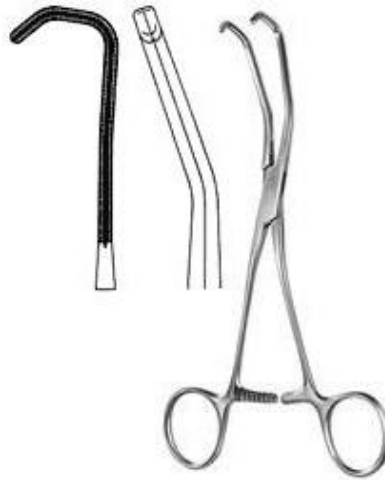

**Cooley**  
**QDI-9-205-17**  
Anastomosis Clamp  
Finish, Satin, 20 cm



**Cooley**  
**QDI-9-206-16**  
Anastomosis Clamp  
Finish, Satin, 17 cm



**Cooley**  
**QDI-9-207-15**  
Multi purpose Vascular Clamp  
Finish, Satin, 16 cm



**Cooley**  
**QDI-9-208-17**  
Multi purpose Vascular Clamp  
Finish, Satin, 17 cm



**Cooley**  
**QDI-9-209-17**  
Multi purpose Vascular Clamp  
Finish, Satin, 17 cm



**Cooley**

**QDI-9-210-17**

Multi purpose Vascular Clamp  
Finish, Satin, 17.5 cm

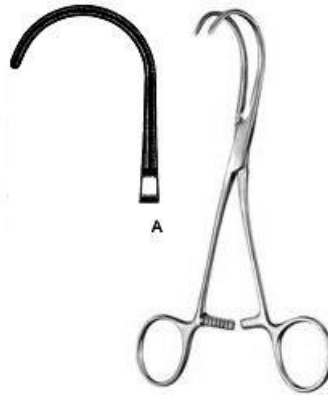

**Cooley**

**QDI-9-211-16**

Multi purpose Vascular Clamp  
Finish, Satin, 16.5 cm



**Cooley-Derra**

**QDI-9-212-16**

Anastomosis Clamp  
Finish, Satin, 16.5 cm



**Cooley-Beck**

**QDI-9-213-17**

Anastomosis Clamp  
Finish, Satin, 17 cm

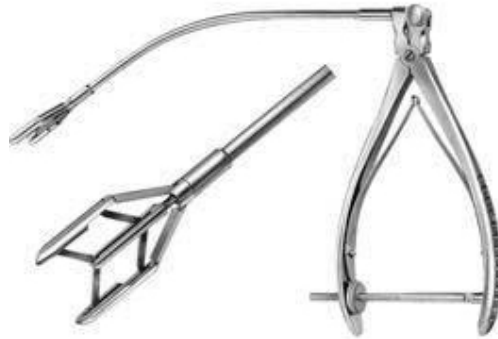

**Cooley**

**QDI-9-214-00**

Aortic Dilator  
Finish, Satin



**Cooley**

**QDI-9-215-05**

Vascular Dilator  
Finish, Satin, 14 cm / 5 ø 11



**DeBakey**  
**QDI-9-216-05**  
Vascular Dilator  
Finish, Satin, 19 cm



**Martin**  
**QDI-9-217-00**  
Tunneling Set complete set with three shafts, two handles and 12 tips in storage case.  
Finish, Satin



**Hach**  
**QDI-9-218-01**  
Fasciotomy Knife with plastic handle  
Finish, Satin, 30 cm



**Intima Spatula**  
**QDI-9-219-18**  
Intima Spatula  
Finish, Satin, 18.5 cm

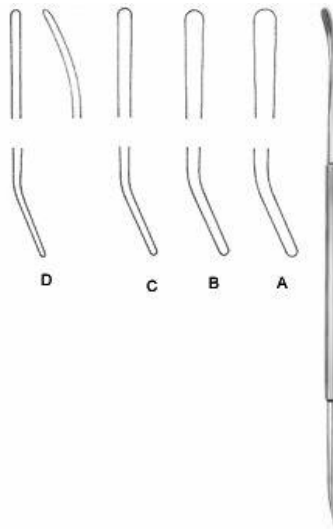

**Robb**  
**QDI-9-220-01**  
Vascular Dissector  
Finish, Satin, 24 cm Fig. 1 2,5 mm ? , 24 cm Fig. 2 2,0 mm ?



**Crile**  
**QDI-9-221-20**  
Nerve Hooklet  
Finish, Satin, 20 cm

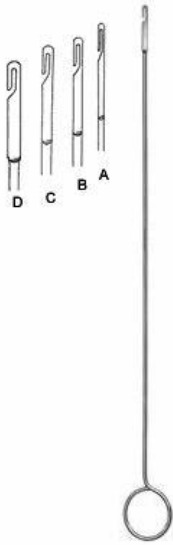

**Ligature Catcher**

**QDI-9-222-15**

Ligature Catcher  
Finish, Satin, 26 cm 1,5 mm

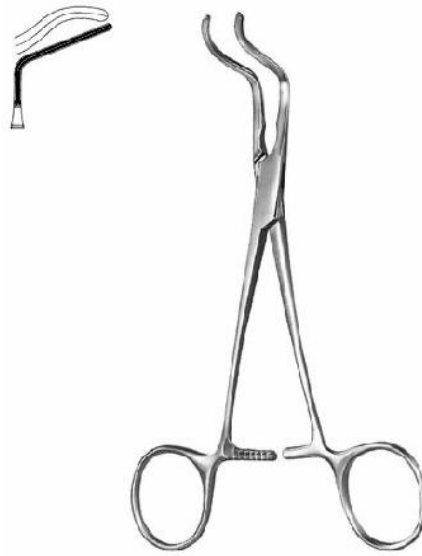

**Subramanian-Miniature**

**QDI-9-223-15**

Aortic Clamp 135 degree  
Finish, Satin, 15.5 cm

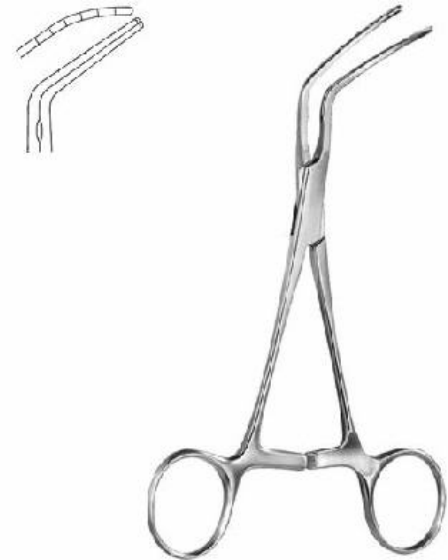

**Subramanian**

**QDI-9-224-16**

Aortic Clamp  
Finish, Satin, 16 cm

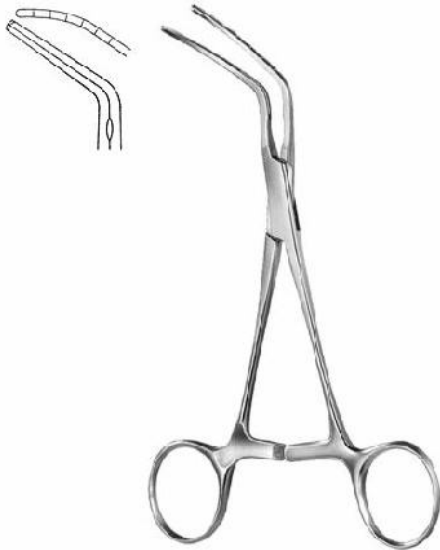

**Subramanian**

**QDI-9-225-16**

Aortic Clamp  
Finish, Satin, 14 cm Fig. 1 , 14 cm Fig. 2 , 14 cm Fig. 3

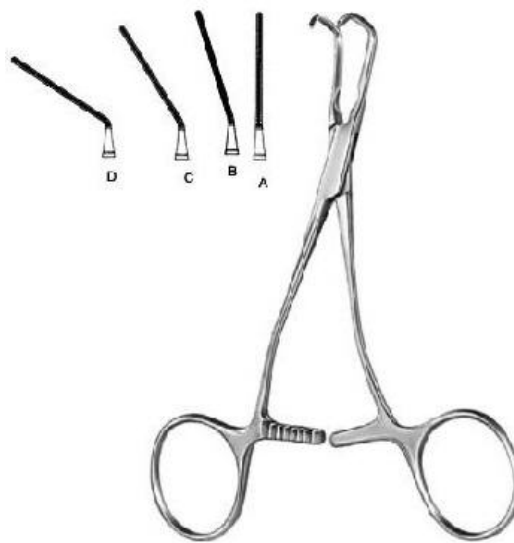

**Pediatric Vascular Clamp**

**QDI-9-226-01**

Pediatric Vascular Clamp



**Pediatric Vascular Clamp**

**QDI-9-227-16**

Pediatric Vascular Clamp  
16.5 cm



**Pediatric Vascular Clamp**

**QDI-9-228-16**

Pediatric Vascular Clamp  
Finish, Satin, 16 cm

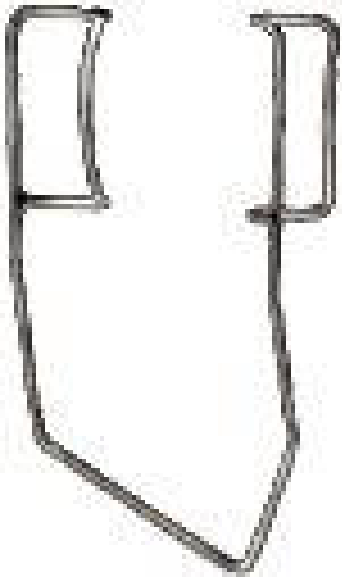

**Barraquer (Colibri)**

**QDI-11-101-03**

Barraquer  
Polish Finish, Satin, Size 1

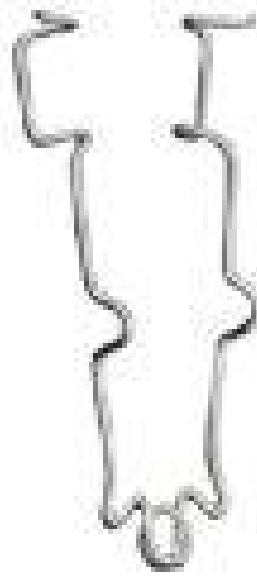

**Bowman**

**QDI-11-102-07**

Bowman  
Finish, Satin, Size 1



**Critchett**

**QDI-11-103-06**

Critchett  
Finish, Satin, Size 1

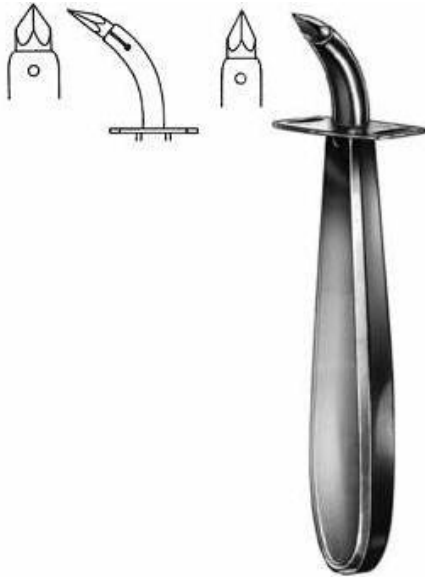

**Ueckermann**

**QDI-16-101-13**

Tracheotomy Trocar  
11.5 cm, Finish, Satin



**Iterson**

**QDI-16-102-16**

Tracheal Hook  
17 cm, Finish, Satin



**Rose**

**QDI-16-103-13**

Tracheal Hook  
13.5 cm, Finish, Satin



**Luer**

**QDI-16-104-11**

Tracheal Hook  
11 cm, Finish, Satin

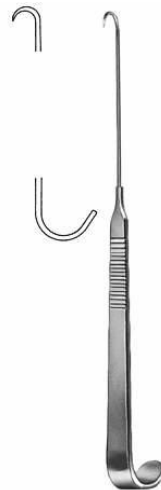

**Tracheal Hook**

**QDI-16-105-15**

Tracheal Hook  
15 cm, Finish, Satin

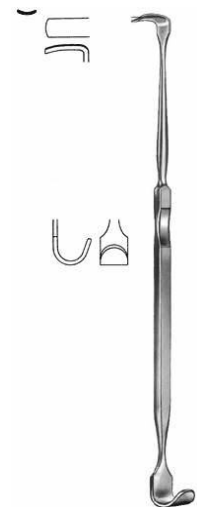

**Lukens**

**QDI-16-106-17**

Thymus Retractor  
17.5 cm, Finish, Satin

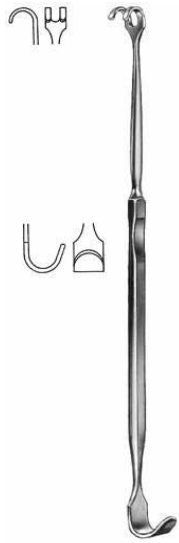

**Jackson**  
**QDI-16-107-17**  
Tracheal Hook  
18 cm, Finish, Satin



**Kocher**  
**QDI-16-108-15**  
Goitre Enucleator  
16.5 cm, Finish, Satin



**Kocher**  
**QDI-16-109-15**  
Goitre Enucleator  
16.5 cm, Finish, Satin



**Hofmeister**  
**QDI-16-110-21**  
Goitre Enucleator  
20.5 cm, Finish, Satin



**Lahey**  
**QDI-16-111-15**  
Goitre Grasping Forceps  
15.5 cm, Finish, Satin



**Luer**  
**QDI-16-112-04**  
Tracheal Tube  
Finish, Satin





**Luer**

**QDI-6-113-08**

Tracheal Tube  
Finish, Satin



**Chevalier-Jackson**

**QDI-16-114-04**

Tracheal Tube outer tube closed inner tube  
closed silver  
Finish, Satin



**Speaking Tube**

**QDI-16-115-08**

Speaking Tube  
Finish, Satin



**Moncorps**  
**QDI-17-101-14**  
Milium Knife  
14 cm, Finish, Satin



**Moncorps**  
**QDI-17-102-00**  
Spare Blade  
Finish, Satin



**Vidal**  
**QDI-17-103-14**  
Lupus Scraper  
13 cm, Finish, Satin



**Wolff**  
**QDI-17-105-01**  
Lupus Curette  
14 cm, Finish, Satin



**Kilner**  
**QDI-17-106-15**  
Skin Hooklet  
14.5 cm, Finish, Satin



**Gillies**  
**QDI-17-107-18**  
Skin Hooklet  
18 cm, Finish, Satin



**Kaye**  
**QDI-17-108-03**  
Face-lift Hook  
13 cm , Finish, Satin

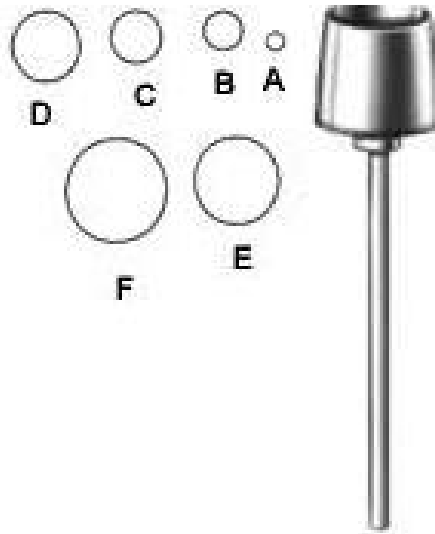

**Dermal Punch**  
**QDI-17-109-02**  
Dermal Punch  
5.5 cm, Finish, Satin



**Handle**  
**QDI-17-110-00**  
Handle  
8 cm, Finish, Satin

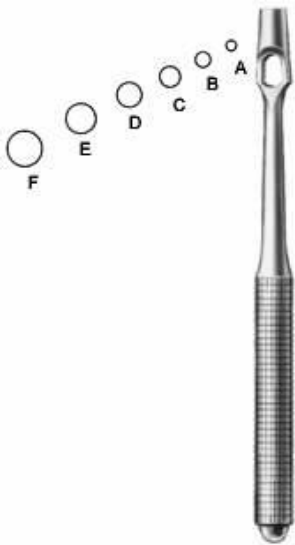

**Keyes**  
**QDI-17-111-02**  
Dermal Punch  
11 cm, Finish, Satin



**Unna**  
**QDI-17-113-14**  
Comedone Extractor  
14.5 cm , Finish, Satin



**Saalfeld**  
**QDI-17-114-10**  
Comedone Extractor  
11 cm, Finish, Satin



**Saalfeld**

**QDI-17-115-14**

Saalfeld Comedone Extractor  
14.5 cm, Finish, Satin



**Schamberg**

**QDI-17-116-10**

Comedone Extractor  
9.5 cm, Finish, Satin



**Katsch**

**QDI-17-117-14**

Comedone Extractor  
16 cm, Finish, Satin



**Unna-Vidal**

**QDI-17-118-11**

Comedone Extractor  
11.5 cm, Finish, Satin



**D'Assump?**

**QDI-17-119-15**

Face-lift Forceps  
18 cm, Finish, Satin



**Gregory**

**QDI-17-120-14**

Face-lift Scissors  
14 cm, Finish, Satin

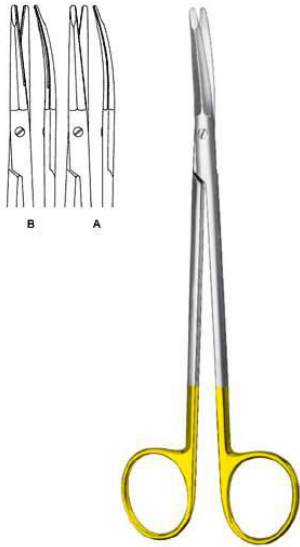

**Kaye**

**QDI-17-121-15**

Face-lift Scissors

15 cm, 18 cm, Finish, Satin

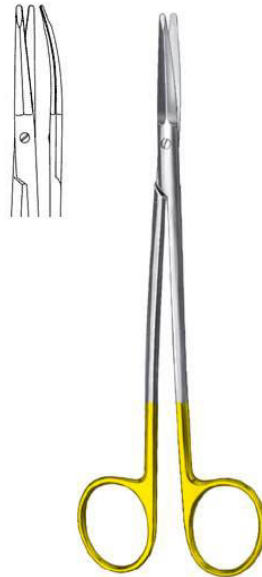

**Stella-S**

**QDI-17-122-18**

Face-lift Scissors

18 cm, Finish, Satin

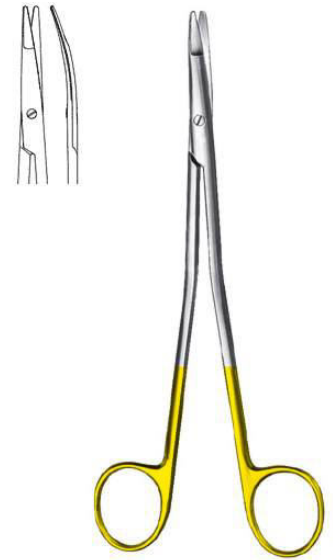

**Gorney**

**QDI-17-123-18**

Face-lift Scissors

18 cm, Finish, Satin

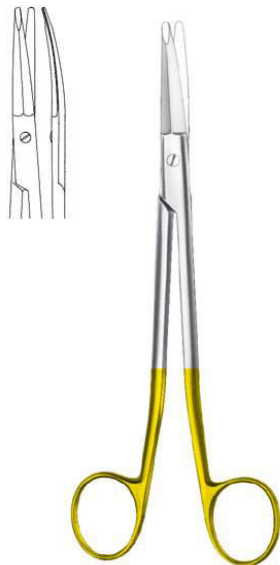

**Freeman-Kaye**

**QDI-17-124-18**

Face-lift Scissors

18 cm, Finish, Satin

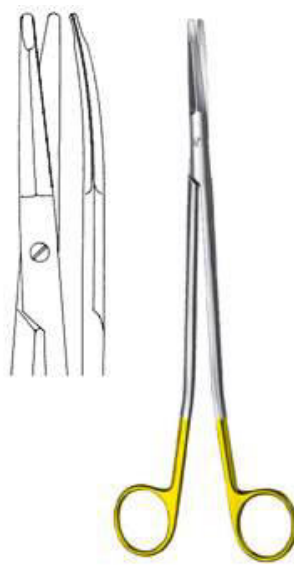

**Freeman**

**QDI-17-125-00**

Face-lift Scissors

23 cm, Finish, Satin



**Fox**

**QDI-17-104-01**

Lupus Curette

14 cm, Finish, Satin

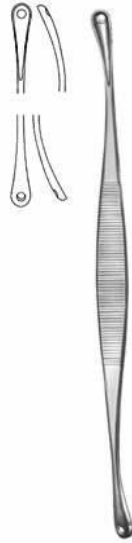

**Unna**

**QDI-17-112-14**

Comedone Extractor  
14.5 cm , Finish, Satin



**Allis-Baby**

**QDI-18-101-12**

Intestinal and Tissue Grasping Forceps  
13 cm , Finish, Satin

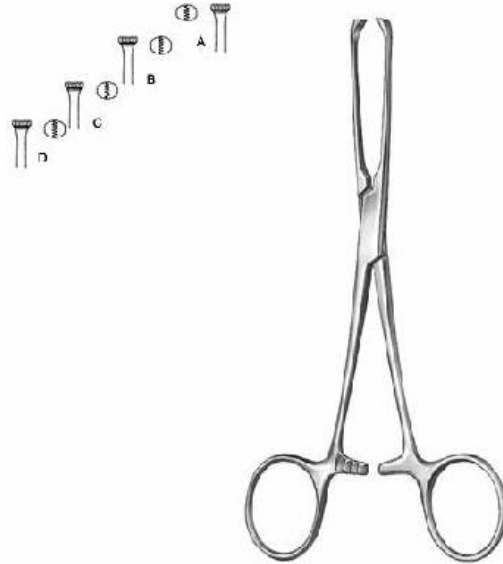

**Allis**

**QDI-18-102-15**

Intestinal and Tissue Grasping Forceps  
15.5 cm, 19 cm , 25.5 cm, Finish, Satin

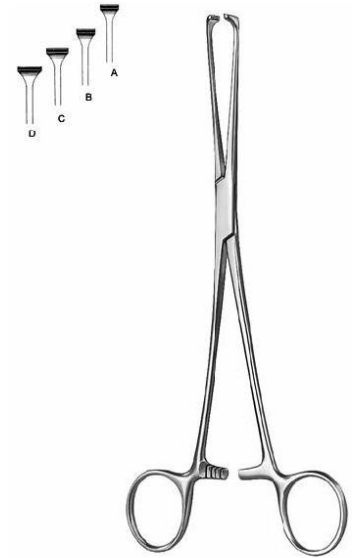

**Allis**

**QDI-18-103-16**

Intestinal and Tissue Grasping Forceps  
15.5 cm, 20 cm, 24.5 cm, 30 cm, Finish, Satin



**Allis-Adair**

**QDI-18-104-15**

Intestinal and Tissue Grasping Forceps  
16 cm, Finish, Satin



**Boys-Allis**

**QDI-18-105-15**

Intestinal and Tissue Grasping Forceps  
15.5 cm, Finish, Satin



**Thoms-Allis**

**QDI-18-106-20**

Intestinal and Tissue Grasping Forceps  
20.5 cm, Finish, Satin



**Allis**

**QDI-18-107-20**

Intestinal and Tissue Grasping Forceps  
20 cm, Finish, Satin

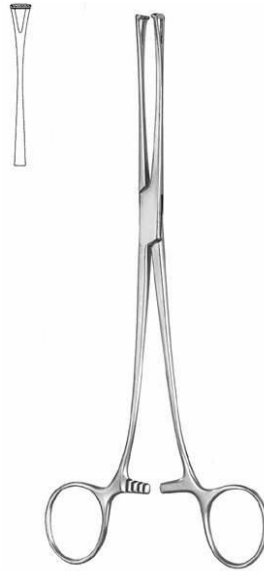

**Lockwood**

**QDI-18-108-20**

Intestinal and Tissue Grasping Forceps  
20 cm, Finish, Satin



**Williams**

**QDI-18-109-16**

Intestinal and Tissue Grasping Forceps  
16.5 cm, Finish, Satin

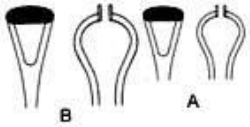

**Babcock**

**QDI-18-110-16**

Intestinal and Tissue Grasping Forceps  
16.5 cm, 21 cm, Finish, Satin

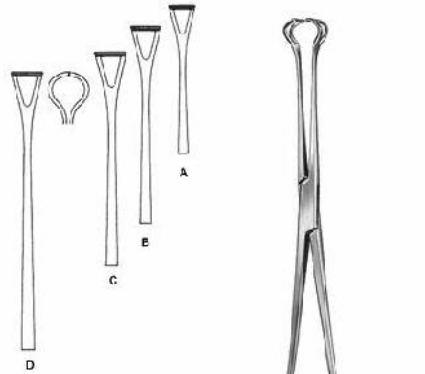

**Babcock**

**QDI-18-111-16**

Intestinal and Tissue Grasping Forceps  
15.5 cm, 17.5 cm, 21 cm, 24 cm, Finish, Satin

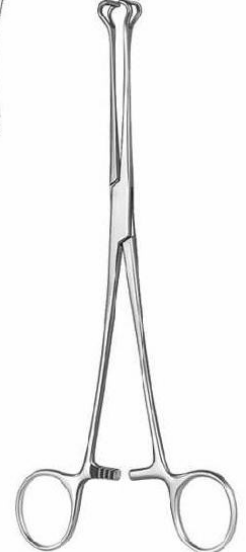
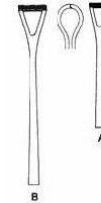

**Babcock**

**QDI-18-112-16**

Intestinal and Tissue Grasping Forceps  
16.5 cm, 25.5 cm, Finish, Satin





**Duval**

**QDI-18-113-20**

Intestinal and Tissue Grasping Forceps  
20.5 cm, Finish, Satin

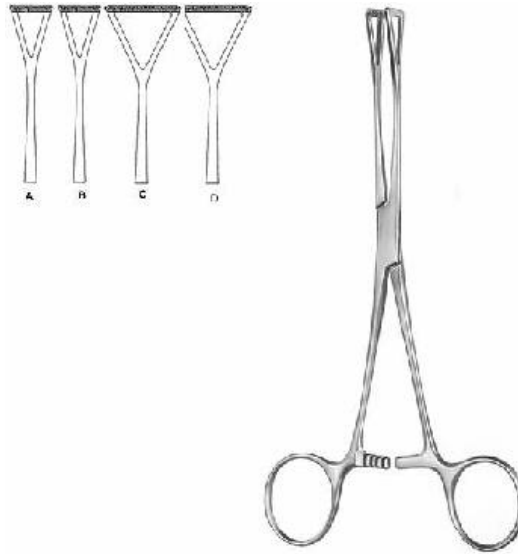

**Duval**

**QDI-18-114-18**

Intestinal and Tissue Grasping Forceps  
18 cm, 25.5 cm, 23 cm, Finish, Satin

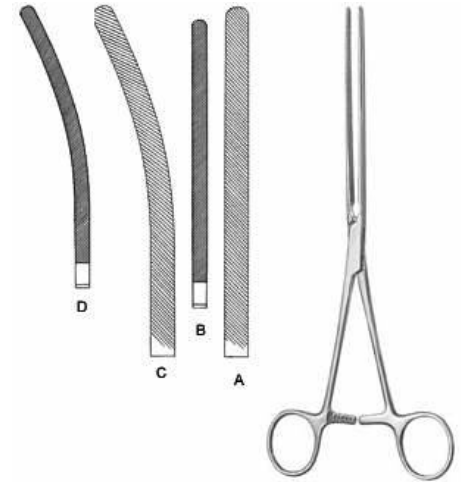

**Doyen**

**QDI-18-115-21**

Intestinal Clamp  
21.5 cm, 23.5 cm, Finish, Satin

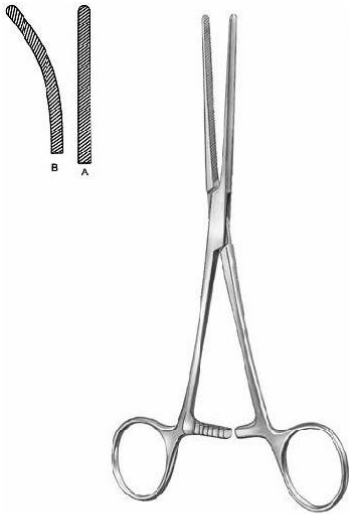

**Doyen-Baby**

**QDI-18-116-18**

Intestinal Clamp  
18 cm, 17.5 cm, Finish, Satin

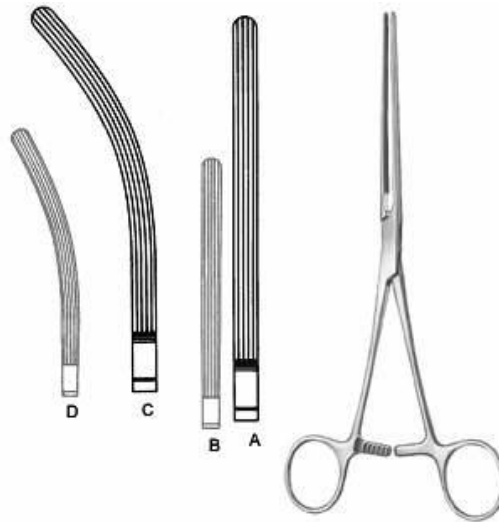

**Mayo-Robson**

**QDI-18-117-21**

Intestinal Clamp  
21.5 cm, 23.5 cm, 23 cm, Finish, Satin

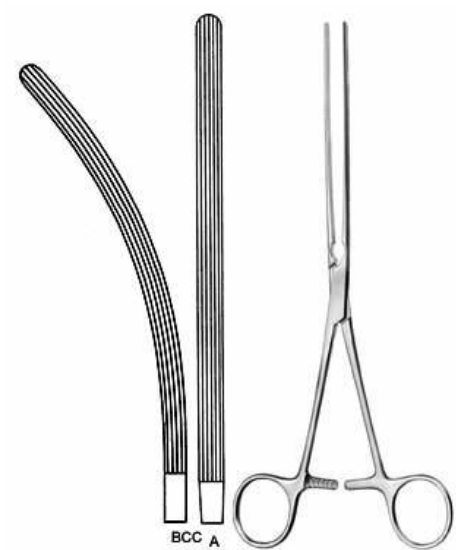

**Mayo-Robson**

**QDI-18-118-25**

Intestinal Clamp  
25.5 cm, 24.5 cm, Finish, Satin

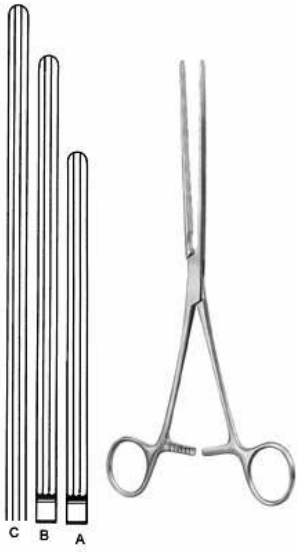

**Kocher**

**QDI-18-119-22**

Intestinal Clamp

22.5 cm, 25 cm, 28.5 cm, Finish, Satin

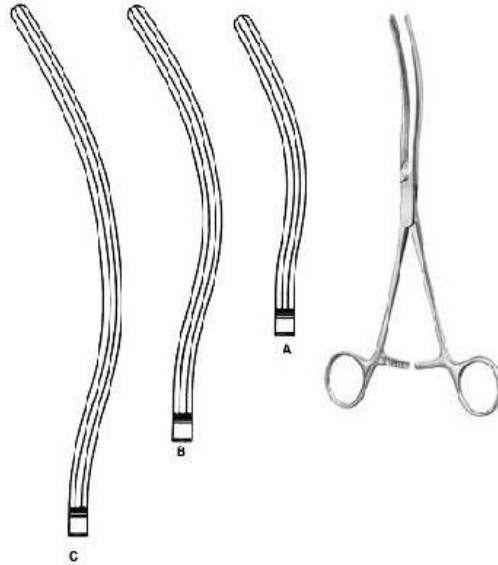

**Kocher**

**QDI-18-120-22**

Intestinal Clamp

22 cm, 24.5 cm, 27.5 cm, Finish, Satin



**Allen**

**QDI-18-121-16**

Intestinal Clamp

16 cm, Finish, Satin



**Payr-Baby**

**QDI-18-122-15**

Intestinal and Pylorus Clamp

15 cm, Finish, Satin

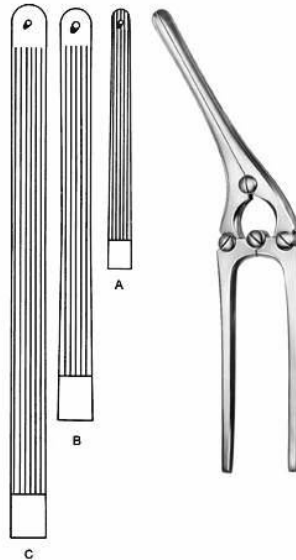

**Payr**

**QDI-18-123-21**

Intestinal and Pylorus Clamp

20.5 cm, 29 cm, 34.5 cm, Finish, Satin



**Stone-Watt**

**QDI-18-124-07**

Intestinal Anastomosis Clamp

8.5 cm, 10 cm, Finish, Satin



**Stone-Watt**  
**QDI-18-125-15**  
Closing Forceps  
Finish, Satin

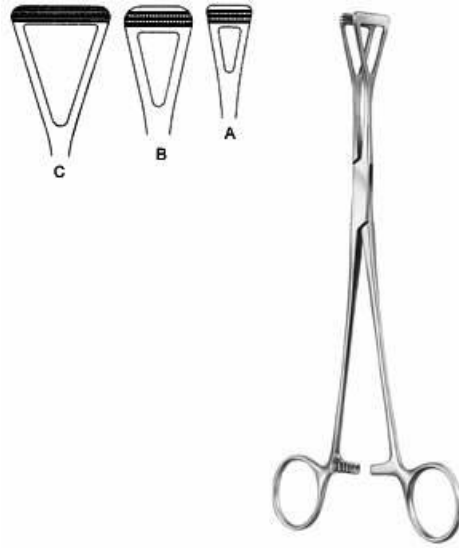

**Scheibe**  
**QDI-18-126-18**  
Organ Grasping Forceps  
18 cm, Finish, Satin

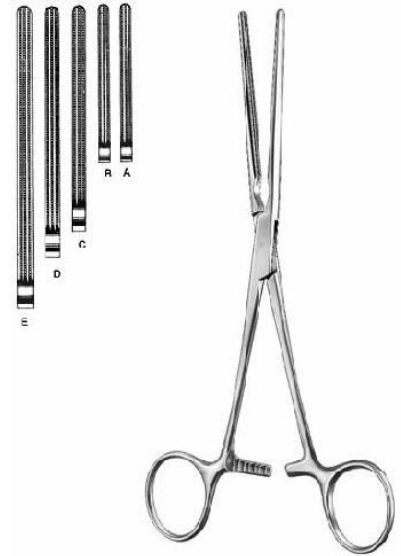

**Doyen-Baby**  
**QDI-18-127-13**  
Intestinal Clamp  
14 cm, 17 cm, Finish, Satin

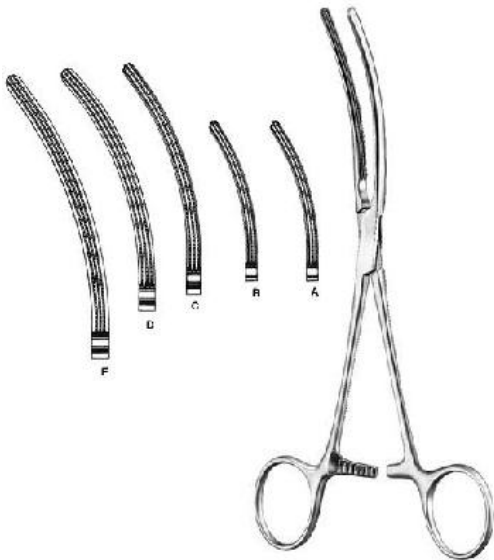

**Doyen-Baby**  
**QDI-18-128-13**  
Intestinal Clamp  
13.5 cm, 17 cm, Finish, Satin



**Mayo-Robson**  
**QDI-18-129-25**  
Intestinal Clamp  
26 cm, Finish, Satin



**Mayo-Robson**  
**QDI-18-130-25**  
Intestinal Clamp  
25 cm, Finish, Satin

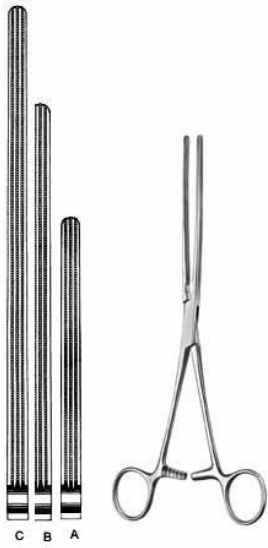

**Kocher**

**QDI-18-131-22**

Intestinal Clamp

22.5 cm, 28 cm, Finish, Satin

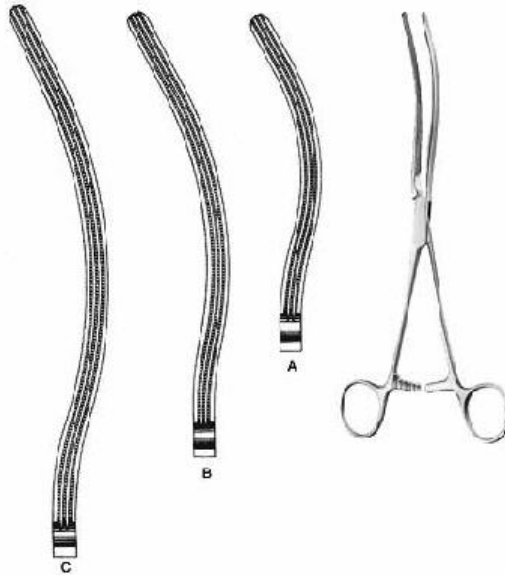

**Kocher**

**QDI-18-132-22**

Intestinal Clamp

22 cm, 25 cm, 27.5 cm, Finish, Satin

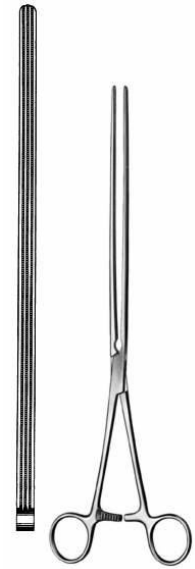

**Scudder**

**QDI-18-133-33**

Intestinal Clamp

33.5 cm, Finish, Satin

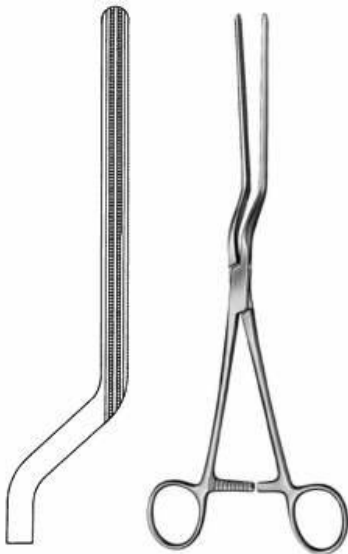

**Brunner**

**QDI-18-134-24**

Sigmoid Anastomosis Forceps

27 cm, Finish, Satin

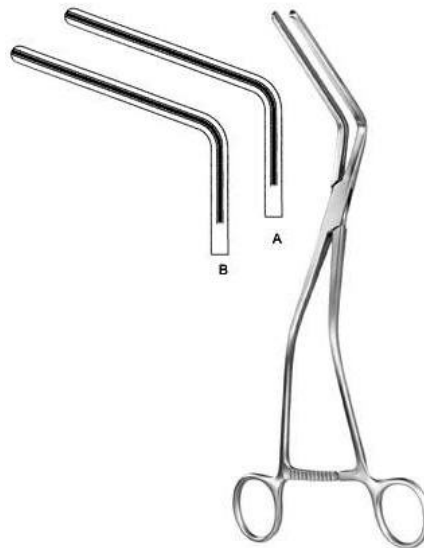

**Hayes**

**QDI-18-135-26**

Sigmoid Anastomosis Forceps

27 cm, 28 cm, Finish, Satin



**Veidenheimer**

**QDI-18-136-23**

Sigmoid Anastomosis Forceps

25 cm, Finish, Satin



**Fehland**

**QDI-18-137-24**

Sigmoid Anastomosis Forceps  
24 cm , Finish, Satin

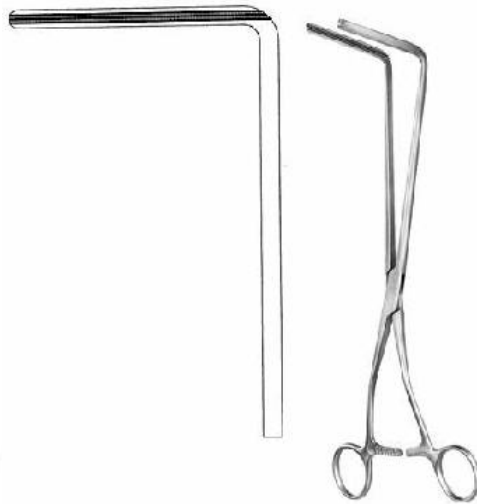

**Resano**

**QDI-18-138-30**

Sigmoid Anastomosis Forceps  
28 cm, Finish, Satin



**Sims**

**QDI-18-139-15**

Rectal Speculum  
15.5 cm, Finish, Satin



**Sims**

**QDI-18-140-15**

Rectal Speculum  
15.5 cm, Finish, Satin



**Mathieu**

**QDI-18-141-19**

Rectal Speculum  
19 cm , Finish, Satin



**Alan-Parks**

**QDI-18-142-00**

Alan-Parks  
14 cm, Finish, Satin

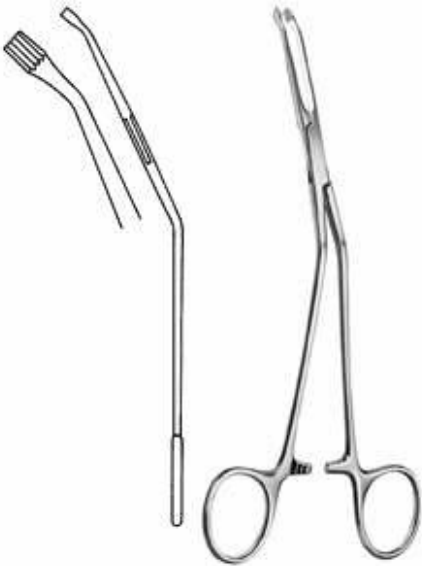

**McGinvey**

**QDI-18-143-19**

Hemorrhoidal Grasping Forceps  
19 cm , Finish, Satin



**Handle For Biopsy Forceps**

**QDI-18-144-00**

Handle for biopsy forceps  
Finish, Satin



**Rectal Biopsy Forceps**

**QDI-18-145-38**

Rectal Biopsy Forceps  
Finish, Satin

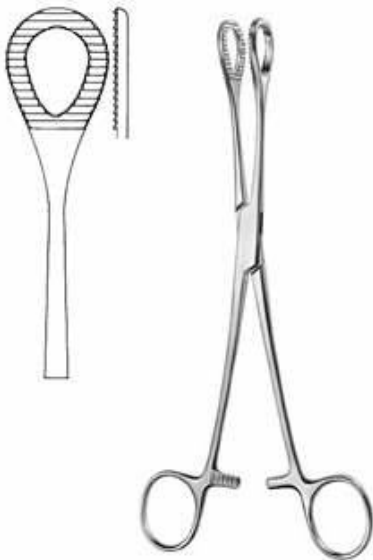

**Heywood-Smith**

**QDI-18-146-21**

Polypus Grasping Forceps  
21 cm, Finish, Satin

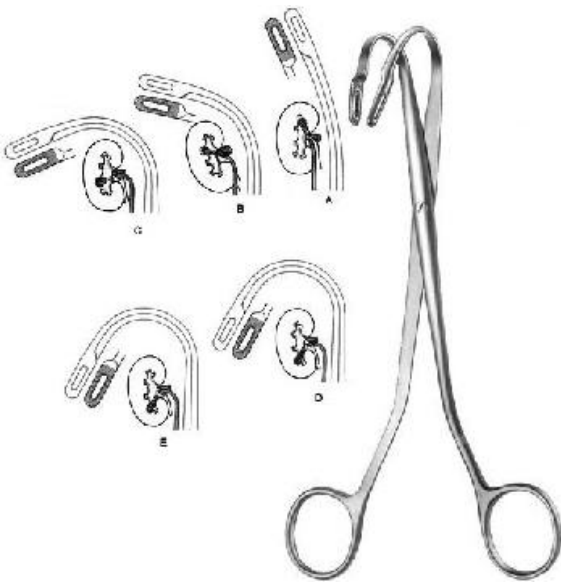

**Randall**

**QDI-19-101-23 A**

Kidney Stone Forceps

23 cm Fig. 1 , 21 cm Fig. 2, 21 cm Fig. 3

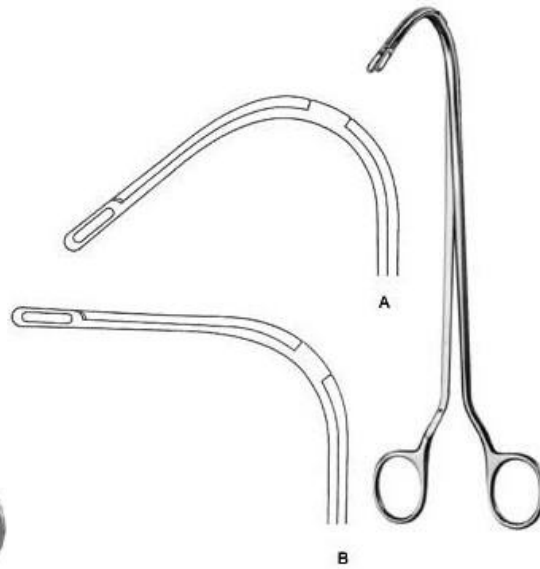

**Randall**

**QDI-19-102-23 A**

Kidney Stone Forceps

23 cm , 24.5 cm

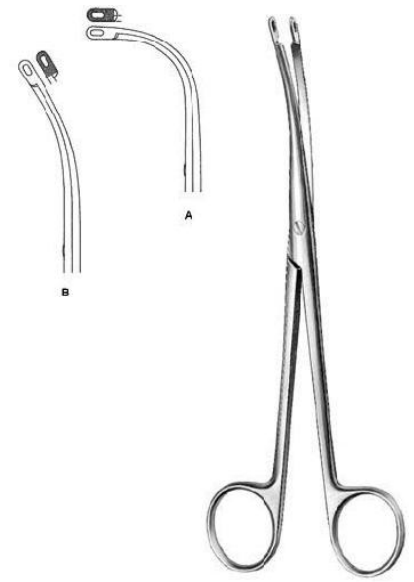

**Heiming**

**QDI-19-103-16 A**

Kidney Stone Forceps

16 cm Fig. 1, 17 cm Fig. 2

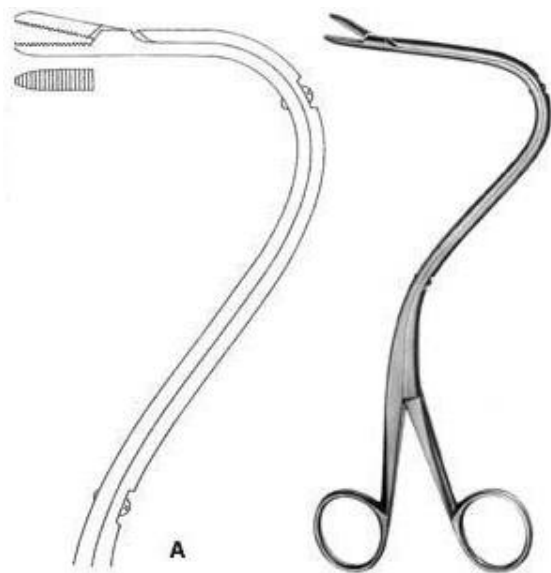

**Elsasser**

**QDI-19-104-01 A**

Nephrostomy Forceps

21 cm Fig. 1 , 21 cm Fig. 2

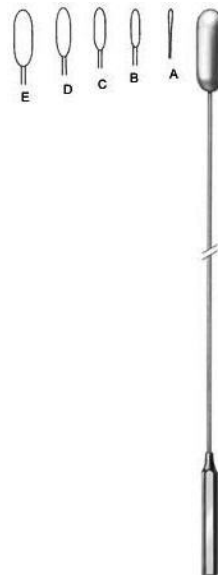

**Bakes**

**QDI-19-105-01 A**

Gall Duct Dilator

32 cm

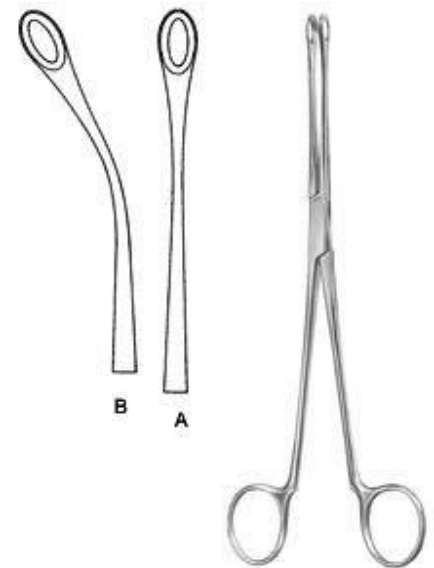

**Blake**

**QDI-19-106-20 A**

Gall Stone Forceps

21 cm



**Mayo-Blake**  
**QDI-19-107-20**  
Gall Stone Forceps  
21 cm



**Mayo-Blake**  
**QDI-19-108-20**  
Gall Stone Forceps  
21 cm



**Mixer**  
**QDI-19-109-22**  
Gall Stone Forceps  
21.5 cm



**Desjardins**  
**QDI-19-110-23 A**  
Gall Stone Forceps  
23 cm

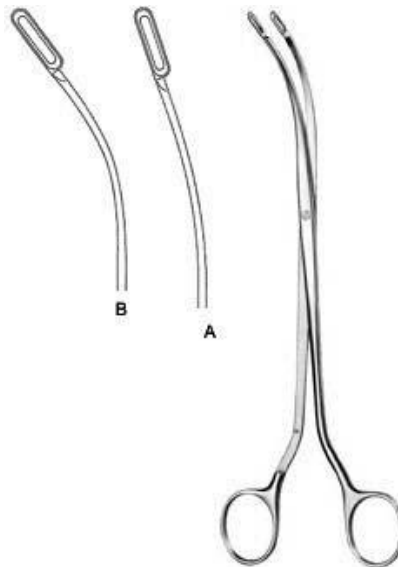

**Desjardins**  
**QDI-19-111-24 A**  
Gall Stone Forceps



**Luer-Korte**  
**QDI-19-112-01 A**  
Gall Stone Scoop  
32 cm Fig. 0, 32 cm Fig. 00, 32 cm Fig. 000, 32 cm Fig. 1, 32 cm Fig. 2, 32 cm Fig. 3, 32 cm Fig. 4



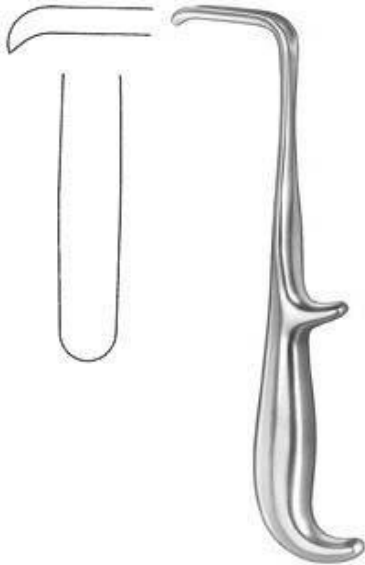

**Young**  
**QDI-19-113-21**  
Prostatic Retractor  
21.5 cm



**Young**  
**QDI-19-114-22**  
Prostatic Retractor  
20.5 cm



**Young**  
**QDI-19-115-21**  
Prostatic Retractor  
22 cm

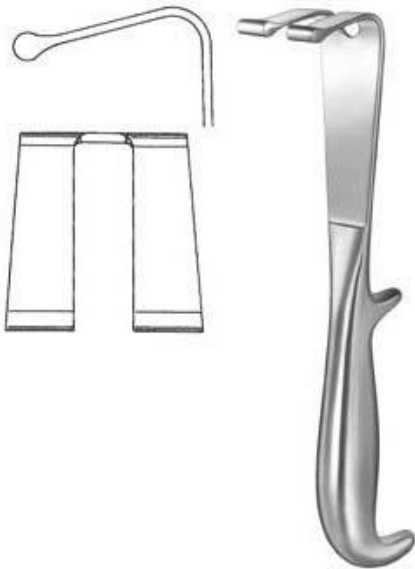

**Young**  
**QDI-19-116-22**  
Prostatic Retractor  
21.5 cm



**Millin**  
**QDI-19-117-24**  
Capsule Forceps  
24.5 cm

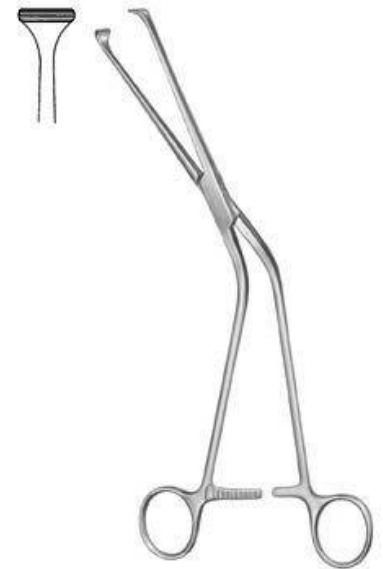

**Millin**  
**QDI-19-118-24**  
Capsule Forceps  
22 cm

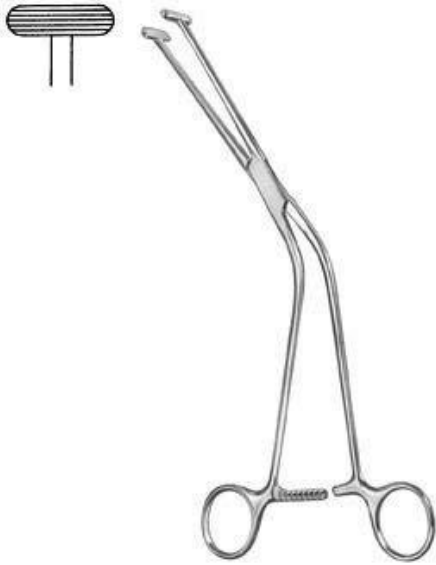

**Millin**  
**QDI-19-119-23**  
Capsule Forceps  
24.5 cm

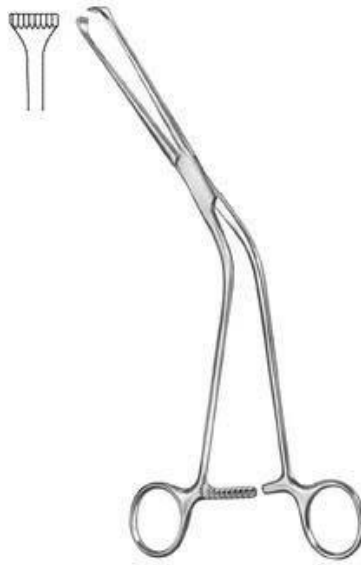

**Millin**  
**QDI-19-120-23**  
Capsule Forceps  
22 cm

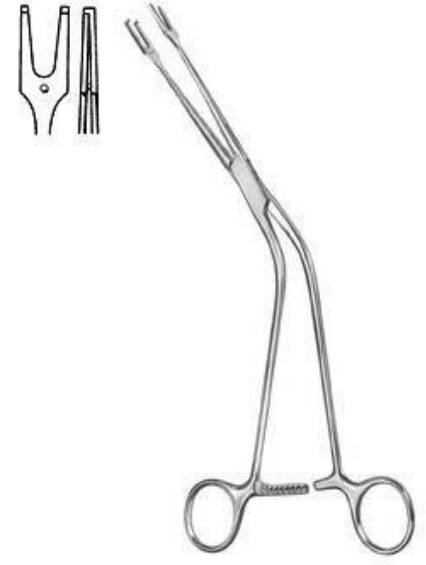

**Millin**  
**QDI-19-121-24**  
Ligature Carrying Forceps  
24.5 cm



**Millin**  
**QDI-19-122-00**  
Bladder Neck Spreader  
29



**Thomson-Walker**  
**QDI-19-123-00**  
Bladder Retractor



**Judd-Masson**  
**QDI-19-124-00**  
Bladder Retractor



**Millin**

**QDI-19-125-00 A**  
Bladder Retractor



**Legueu**

**QDI-19-126-27**  
Bladder Spatula  
24 cm , 35 mm

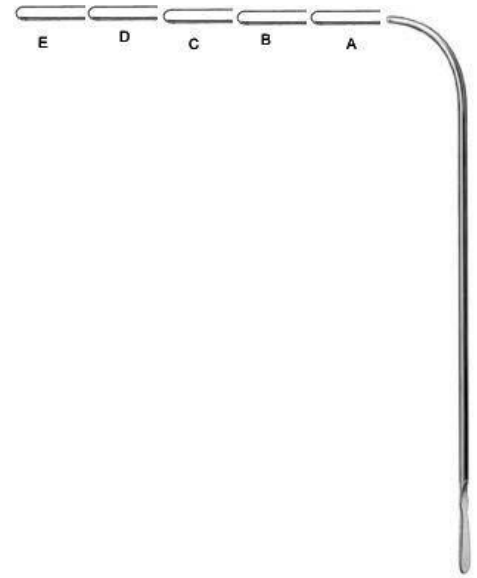

**Van Buren**

**QDI-19-127-00 A**  
Urethral Sound  
27.5 cm

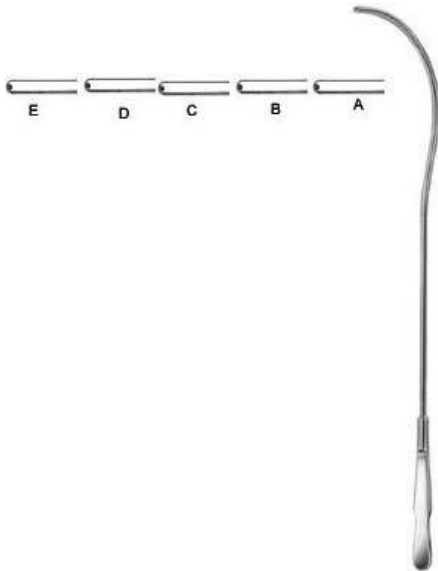

**Guyon**

**QDI-19-128-10 A**  
Urethral Sound  
26 cm



**Cusco**

**QDI-20-101**

Vaginal Speculum

Finish, Satin, 75 x 32 mm, 85 x 35 mm



**Cusco**

**QDI-20-102-01**

Vaginal Speculum

Finish, Satin, 75 x 18 mm



**Cusco**

**QDI-20-103-01**

Vaginal Speculum

Finish, Satin, 80 x 22 mm, 100 x 25 mm, 105 x 27 mm



**Cusco**

**QDI-20-104-01**

Vaginal Speculum

Finish, Satin, 75 x 34 mm, 85 x 37 mm



**Collin**

**QDI-20-105-01**

Vaginal Speculum

Finish, Satin, 85 x 30 mm, 100 x 35 mm

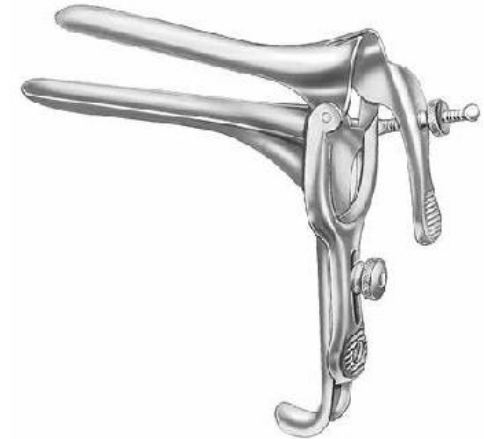

**Pederson**

**QDI-20-106-01**

Vaginal Speculum

Finish, Satin, 75 x 13 mm, 100 x 22 mm



**Grave**

**QDI-20-107-01**

Vaginal Speculum

75 x 20 mm, 95 x 35 mm, Finish, Satin



**Semm**

**QDI-20-108-01**

Vaginal Speculum

100 x 20 mm, 105 x 27 mm, Finish, Satin



**Sims**

**QDI-20-109-01**

Vaginal Speculum

65 x 25 mm, 70 x 30 mm, Finish, Satin



**Kristeller**

**QDI-20-110-01**

Vaginal Speculum

70 x 27 mm, Finish, Satin



**Kristeller**

**QDI-20-111-01**

Vaginal Retractor

75 x 23 mm, Finish, Satin



**Kristeller**

**QDI-20-112-01**

Vaginal Speculum

Size 1, Finish, Satin



**Kristeller**  
**QDI-20-113-01**  
Vaginal Speculum  
105 x 18 mm, Finish, Satin



**Kristeller**  
**QDI-20-114-01**  
Vaginal Retractor  
110 x 14 mm, Finish, Satin



**Kristeller**  
**QDI-20-115-01**  
Vaginal Speculum  
Size 1, Finish, Satin

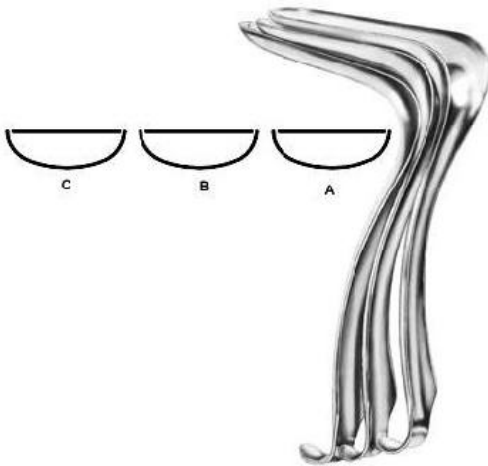

**Kristeller**  
**QDI-20-116-01**  
Vaginal Speculum  
105 x 26 mm, Finish, Satin

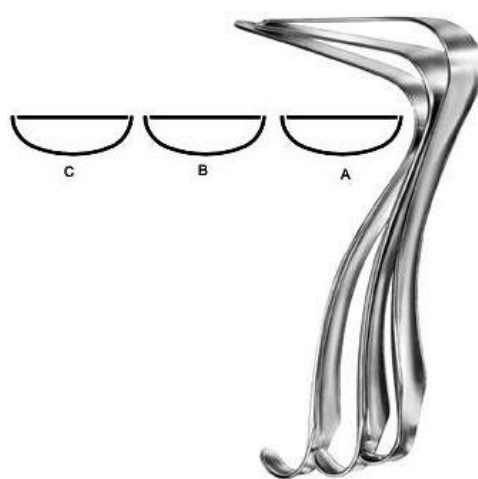

**Kristeller**  
**QDI-20-117-01**  
Vaginal Retractor  
115 x 22 mm, 115 x 23 mm, Finish, Satin

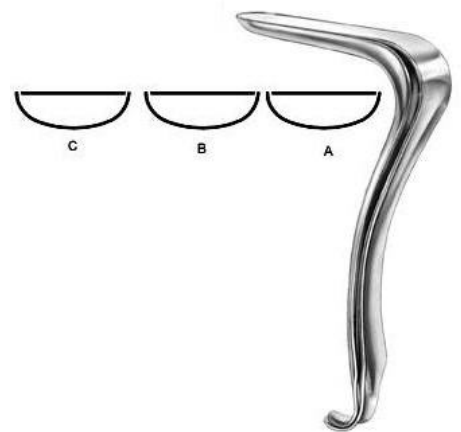

**Kristeller**  
**QDI-20-118-01**  
Vaginal Speculum  
Size 1, Finish, Satin

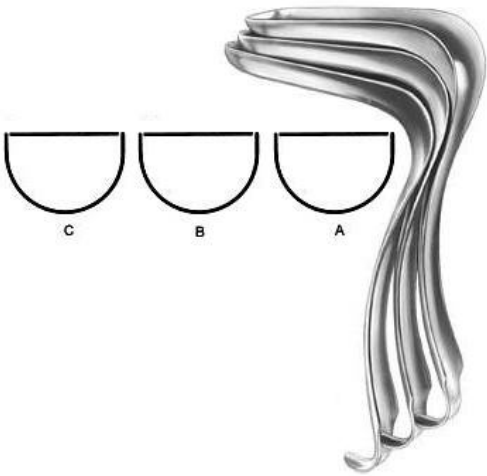

**Kristeller**

**QDI-20-119-01**

Vaginal Speculum

110 x 27 mm, Finish, Satin

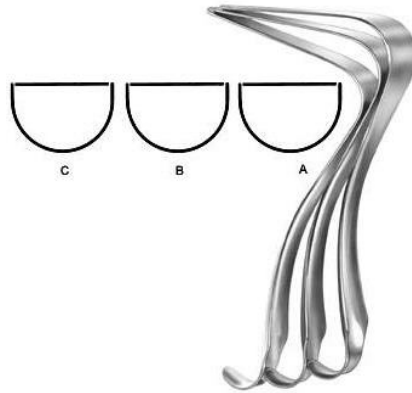

**Kristeller**

**QDI-20-120-01**

Vaginal Retractor

115 x 23 mm, Finish, Satin

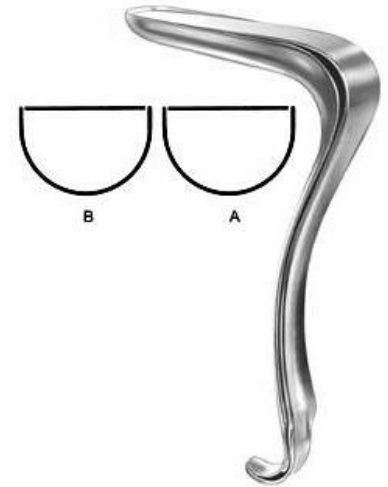

**Kallmorgen**

**QDI-20-121-01**

Vaginal Speculum



**Kallmorgen**

**QDI-20-122-01**

Vaginal Retractor

70 x 40 mm Fig. 1, 90 x 40 mm Fig. 2, Finish, Satin



**Kallmorgen**

**QDI-20-123-01**

Vaginal Speculum

70 x 33 mm, 90 x 33 mm, Finish, Satin

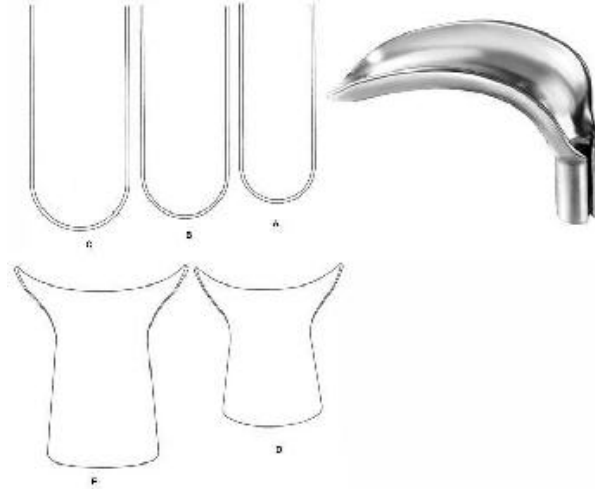

**Scherbak**

**QDI-20-125-00**

Vaginal Speculum

Size 1, Finish, Satin



**Auvard**

**QDI-20-126-22**

Vaginal Speculum  
80 x 43 mm, Finish, Satin



**Weissbarth**

**QDI-20-127-24**

Vaginal Speculum  
21 cm 80 x 42 mm, Finish, Satin



**Breisky**

**QDI-20-128-20**

Vaginal Speculum  
29 cm 100 x 20 mm, 29 cm 100 x 25 mm, Finish, Satin



**Kogan**

**QDI-20-129-24**

Endocervical Speculum  
25 cm 70 x 30 mm, Finish, Satin



**Kogan**

**QDI-20-130-24**

Endocervical Speculum  
24.5 cm, Finish, Satin



**Hegar**

**QDI-20-131-24**

Uterine Dilator  
18.5 cm 1,0, Finish, Satin





**Hegar**

**QDI-20-132-02**

Uterine Dilator  
20 cm 1,0, Finish, Satin



**Hank**

**QDI-20-133-10**

Uterine Dilator  
26.5 cm Fig. 9/10, Finish, Satin



**Sims**

**QDI-20-134-32**

Uterine Sound  
33 cm, Finish, Satin



**Valleix**

**QDI-20-135-25**

Uterine Sound  
29.5 cm, Finish, Satin



**Braun**

**QDI-20-136-26**

Uterine Depressor  
27.5 cm, Finish, Satin



**Schroder**

**QDI-20-137-25**

Uterine Tenaculum Forceps  
25.5 cm, Finish, Satin



**Braun**

**QDI-20-138-25**

Uterine Tenaculum Forceps  
26 cm, Finish, Satin



**Duplay**

**QDI-20-139-28**

Uterine Tenaculum Forceps  
25.5 cm, Finish, Satin



**Beacham**

**QDI-20-140-26**

Amniotome  
26 cm, Finish, Satin



**Skene**

**QDI-20-141-24**

Uterine Tenaculum Forceps  
24 cm, Finish, Satin

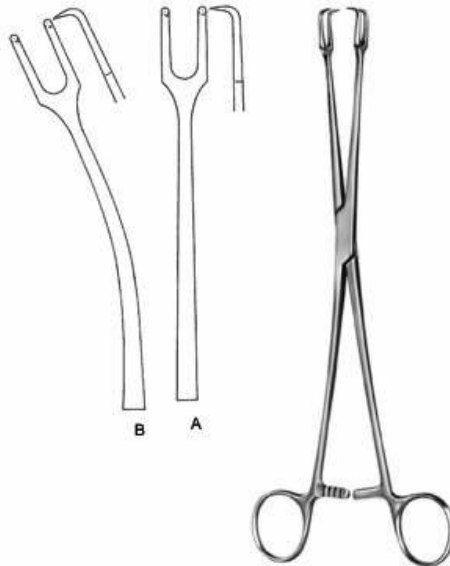

**Schroder**

**QDI-20-142-24**

Uterine Tenaculum Forceps  
25 cm, Finish, Satin



**Teale**

**QDI-20-143-23**

Uterine Tenaculum Forceps  
23.5 cm, Finish, Satin

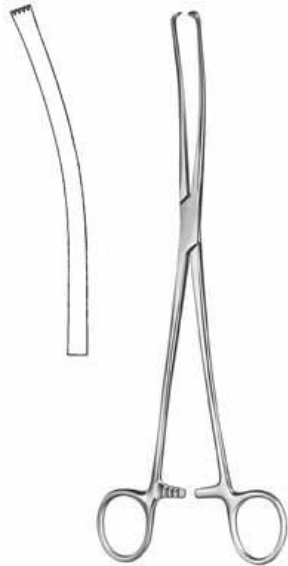

**Iowa**

**QDI-20-144-26**

Uterine Tenaculum Forceps  
26 cm, Finish, Satin

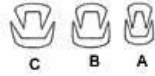

**Museux**

**QDI-20-145-24**

Uterine Tenaculum Forceps  
24 cm , Finish, Satin



**Jacobs**

**QDI-20-146-21**

Uterine Tenaculum Forceps  
21 cm, Finish, Satin

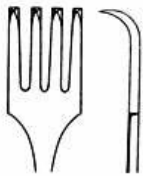

**Uterine Tenaculum Forcep**

**QDI-20-147-26**

Uterine Tenaculum Forcep  
26.5 cm, Finish, Satin



**Braun**

**QDI-20-148-16**

Uterine Tenaculum Forceps  
16 cm, Finish, Satin

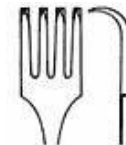

**Czerny**

**QDI-20-149-21**

Uterine Tenaculum Forceps  
21 cm, Finish, Satin



**Kelly**

**QDI-20-150-32**

Uterine Polypus Forceps  
32 cm, Polish Finish, Satin



**Noto**

**QDI-20-151-27**

Uterine Polypus Forceps  
27 cm, Finish, Satin

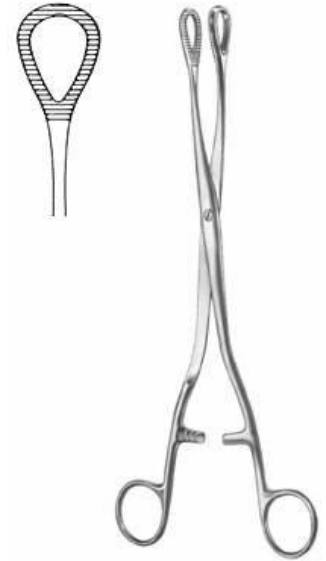

**Heywood-Smith**

**QDI-20-152-25**

Uterine Polypus Forceps  
25 cm, Finish, Satin

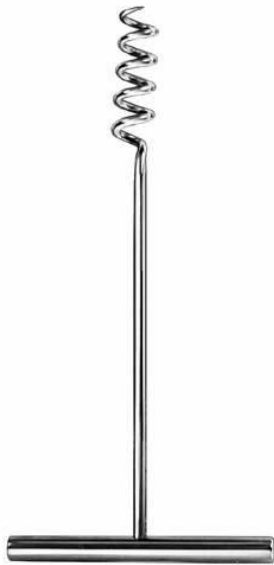

**Doyen**

**QDI-20-153-17**

Myoma Screw  
17 cm, Finish, Satin



**Doyen**

**QDI-20-154-17**

Myoma Screw  
14.5 cm, Finish, Satin



**Segond**

**QDI-20-155-27**

Myoma Knife  
28 cm, Finish, Satin

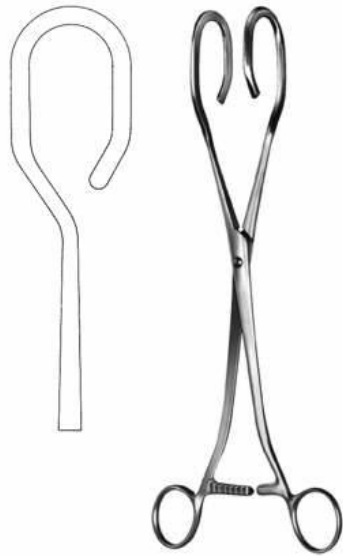

**Dartigues**

**QDI-20-156-27**

Uterine Seizing Forceps  
28 cm, Finish, Satin

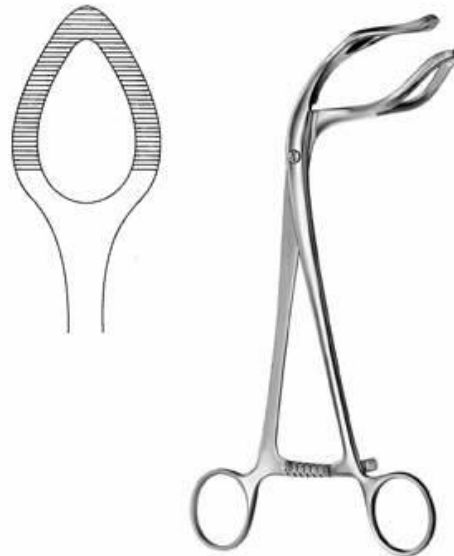

**Somer**

**QDI-20-157-27**

Uterine Seizing Forceps  
22.5 cm



**Collin**

**QDI-20-158-25**

Uterine Seizing Forceps jaw 40 mm wide  
26 cm, Finish, Satin



**Ayre**

**QDI-20-159-23**

Conization Knife cutting edge 3,6 mm wide  
23.5 cm, Finish, Satin



**Emmett**

**QDI-20-160-03**

Fistula Hook  
22 cm Fig.3, Finish, Satin



**Simon**

**QDI-20-161-22**

Fistula Hook  
21.5 cm, Finish, Satin



**Simon**

**QDI-20-162-22**

Fistula Hook  
21.5 cm, Finish, Satin



**Novak**

**QDI-20-163-23**

Suction Curette 4 mm ?  
24.5 cm, Finish, Satin



**Kevorkian**

**QDI-20-164-23**

Uterine Biopsy Curette 6,0 mm ?  
30 cm, Finish, Satin



**Munchen**

**QDI-20-165-27**

Uterine Biopsy Curette 4,8 mm ?  
27 cm, Finish, Satin



**Gellhorn**

**QDI-20-166-23**

Uterine Biopsy Forceps jaw 8,6 mm wide  
24 cm, Finish, Satin



**Faure**

**QDI-20-167-21**

Faure Uterine Biopsy Forceps  
21 cm, Polish Finish, Satin

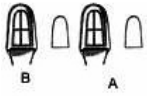

**Schubert**

**QDI-20-168-21**

Uterine Biopsy Forceps jaw 4,8 mm wide  
21.5 cm, 28 cm, Finish, Satin



**Thoms-Gaylor**

**QDI-20-169-22**

Uterine Biopsy Forceps jaw 5,6 mm ?  
21 cm, 23.5 cm, Finish, Satin

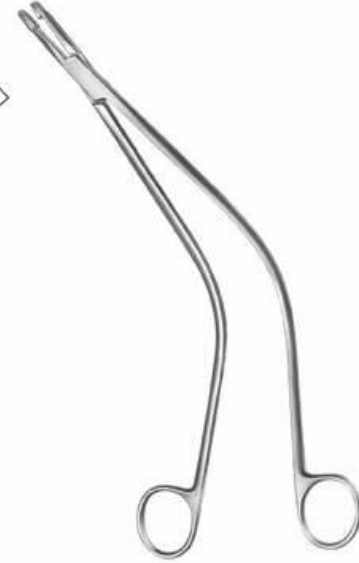

**Schubert**

**QDI-20-170-26**

Schubert Uterine Biopsy Forceps  
25.5 cm, Polish Finish, Satin

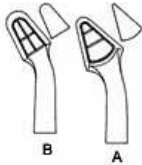

**Van Doren**

**QDI-20-171-24**

Uterine Biopsy Forceps jaw 4,9 mm wide  
27 cm, 25.5 cm, Finish, Satin



**Alexander**

**QDI-20-172-28**

Uterine Biopsy Forceps jaw 5,1 mm wide  
28 cm, Finish, Satin



**Kevorkian**

**QDI-20-173-32**

Uterine Biopsy Forceps  
25 cm, Finish, Satin

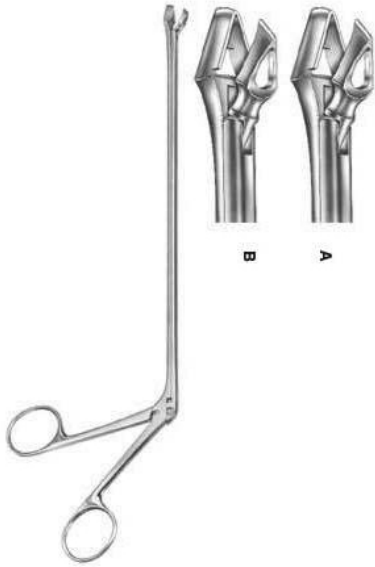

**Schumacher**

**QDI-20-174-01**

Uterine Biopsy Forceps jaw 4,6 / 5,4 mm wide  
24 cm , Finish, Satin



**Schumacher**

**QDI-20-175-00**

Uterine Biopsy Forceps  
25 cm, Finish, Satin



**IUP Grasping Forceps 3 Mm ?**

**QDI-20-176-22**

IUP Grasping Forceps 3 mm ?  
22 cm, Finish, Satin

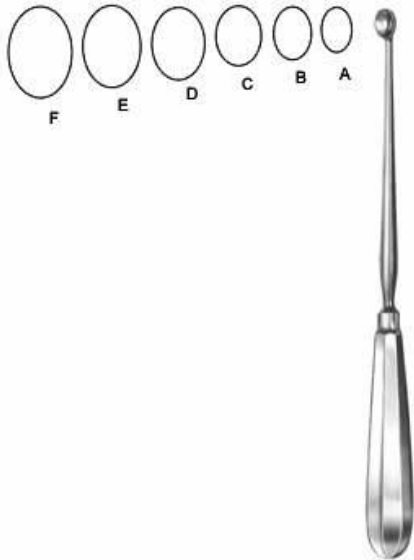

**Simon**

**QDI-20-177-01**

Uterine Scoop

24.5 cm 9,8 x 8,6 mm, Finish, Satin, 24.5 cm 11,6 x 8,3 mm



**Simon**

**QDI-20-178-01**

Uterine Scoop

30 cm 9,8 x 8,6 mm, 30 cm 11,6 x 8,3 mm, Finish, Satin



**Recamier**

**QDI-20-179-05**

Uterine Curette

31 cm Fig. 00 5 mm, 31 cm Fig. 0 6 mm, Finish, Satin





**Recamier**

**QDI-20-180-05**

Uterine Curette

31 cm Fig. 00 5 mm, 31 cm Fig. 0 6 mm, Finish, Satin



**Sims**

**QDI-20-181-05**

Uterine Curette

31 cm Fig. 00 5 mm, 31 cm Fig. 0 6 mm, Finish, Satin

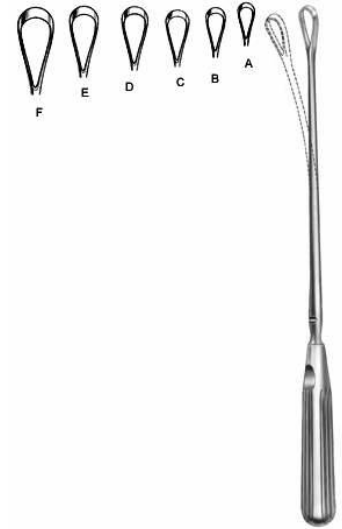

**Sims**

**QDI-20-182-05**

Uterine Curette

31 cm Fig. 00 5 mm, 31 cm Fig. 0 6 mm, Finish, Satin



**Suction Curette**

**QDI-0-183-03**

Suction Curette

29 cm 3,0 mm ?, 29 cm 4,5 mm ?, 29 cm 6,0 mm ?, Finish, Satin



**Martin**

**QDI-21-101-34**

Pelvimeter cm, inch scale  
34 cm



**Nagele**

**QDI-5-102-36**

Obstetrical Forceps  
35 cm, 40.5 cm



**Simpson**

**QDI-5-103-30**

Obstetrical Forceps  
31 cm



**Wrigley**

**QDI-5-104-28**

Obstetrical Forceps  
28 cm



**Simpson**

**QDI-21-105-36**

Obstetrical Forceps  
36.5 cm



**Kielland**

**QDI-21-106-41**

Obstetrical Forceps  
42 cm

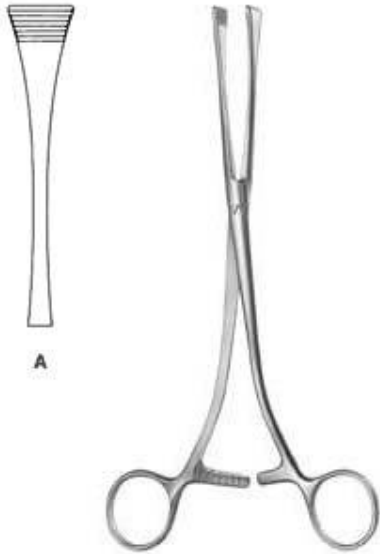

**Green-Armytage**  
QDI-21-107-21  
Uterine Clamp  
21 cm



**Sellheim**  
QDI-21-108-28  
Obstetrical Lever  
32 cm

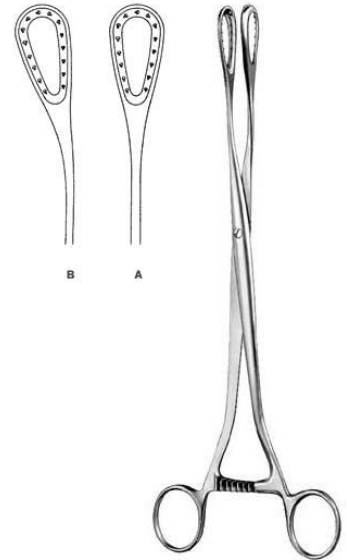

**Sanger**  
QDI-21-109-27  
Placenta and Ovum Forceps  
27.5 cm, 27 cm

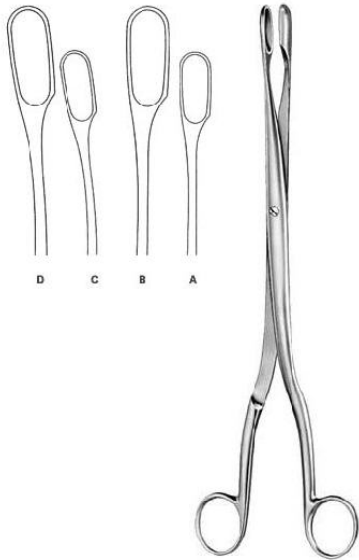

**Winter**  
QDI-21-110-01  
Placenta and Ovum Forceps  
28 cm Fig. 1, 28 cm Fig. 2

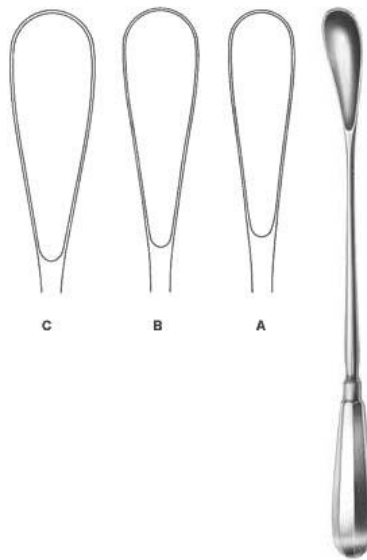

**Cuzzi**  
QDI-21-111-01  
Placenta Scoop  
30 cm 14,5 mm, 30 cm 18 mm



**Pestaloza**  
QDI-21-112-30  
Placenta Scoop  
30 cm

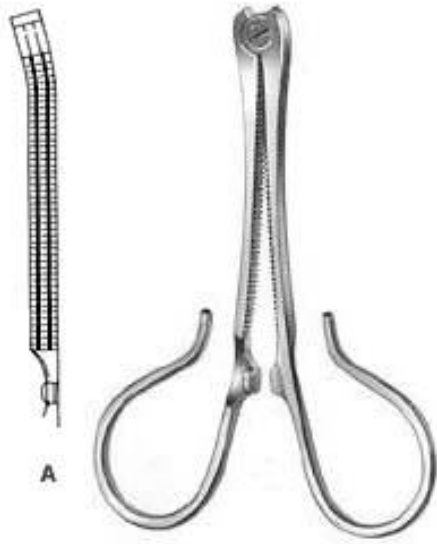

**Kane**

**QDI-21-113-08**

Umbilical Cord Clamp  
8.5 cm



**Collin**

**QDI-21-114-09**

Umbilical Cord Clamp  
8.5 cm



**Irrigator**  
**QDI-23-101-10**  
Sterilization  
Size 1, Finish, Satin



**Round Bowl**  
**QDI-23-102-16**  
Sterilization  
220 mm x 70 mm, 400 mm x 150 mm, Finish, Satin



**Round Bowl**  
**QDI-23-103-33**  
Sterilization  
? x h 6,00 l, Finish, Satin



**Flat Dish**  
**QDI-23-104-11**  
Sterilization  
? x h 0,20 l, Finish, Satin



**Lid Only**  
**QDI-23-105-11**  
Sterilization  
Size 1, Finish, Satin



**Stainless Steel**  
**QDI-23-106-04**  
Sterilization  
? x h 0,30 l, Finish, Satin



**Round Dish**

**QDI-23-107-11**

Sterilization

? x h 0,30 l, ? 128 x 38 mm 0,40 l, Finish, Satin



**Flat Dish**

**QDI-23-108-11**

Sterilization

? x h 0,15 l, Finish, Satin



**Measurer**

**QDI-23-109-01**

Graduated inside

100cc = 0,1 l, Finish, Satin



**Measurer**

**QDI-23-110-02**

Graduated Inside

0,25 l, 0,50 l, Finish, Satin



**Petri Dish**

**QDI-23-111-10**

with Lid ? x h

Finish, Satin



**Petri Dish**

**QDI-23-112-09**

without lid ? x h

Size 1, Finish, Satin



**Lid For Petri Dishes**

**QDI-23-113-10**

Sterilization  
Size 1, Finish, Satin



**Universal Tray**

**QDI-23-114-23**

Sterilization  
l x b x h, Finish, Satin



**Instrument Tray**

**QDI-23-115-21**

Sterilization  
l x b x h, Finish, Satin



**Universal Tray**

**QDI-23-116-23**

Sterilization  
l x b x h, Finish, Satin



**Round Bowl**

**QDI-23-117-22**

Sterilization  
? x h, Finish, Satin



**Metal Jar**

**QDI-23-118-30**

Sterilization  
? 30mm x 90 mm, ? 50mm x 100 mm, Finish, Satin



**Instrument Box**

**QDI-23-119-16**

lid with knob

l x b x h, Finish, Satin



**Instrument Box**

**QDI-23-120-16**

lid with knob

l x b x h, Finish, Satin



**Instrument Box**

**QDI-23-121-20**

Sterilization

l x b x h, Finish, Satin



**Round Metal Box**

**QDI-23-122-06**

Sterilization

? 75 mm x 75 mm, ? 100 mm x 60 mm, Finish,  
Satin



**Medicine Cup Graduated Inside**

**QDI-23-123-25**

Sterilization

25 cm, Finish, Satin



**Medicine Cup Graduated Inside**

**QDI-23-124-50**

Sterilization

50 cm, Finish, Satin





**Tablet Tray**

**QDI-23-125-75**

Sterilization

? 75 mm x 12 mm , Finish, Satin



**Metal Cup**

**QDI-23-126-90**

Sterilization

? 90 mm x 90 mm, Finish, Satin



**Denture Cup**

**QDI-23-127-75**

Sterilization

? 75 mm x 50 mm, Finish, Satin



**Insert For Cup**

**QDI-23-128-75**

Sterilization

? 73 mm x 75 mm, Finish, Satin



**Kidney Dish**

**QDI-23-129-17**

Kidney Dish

l x b x h, Finish, Satin



**Placenta Pan**

**QDI-23-130-36**

Sterilization

Size 1, Finish, Satin



**Waste Cotton Collector**

**QDI-23-131-01**

Sterilization  
? 50 mm x 75 mm, Finish, Satin



**Spirit Lamp**

**QDI-23-132-07**

Sterilization  
120 cm, Finish, Satin



**Quick Dental**  
International

# CATALOGUE



## CONTACT US

**Address:** Post Office Kotla Amban Wala,  
Bheko Chohar, Sialkot-51310 Pakistan.

**Telephone:** +92 317 7115985

**E-mail:** [info@quickdentalintl.com](mailto:info@quickdentalintl.com)

[quickdentalinternational@gmail.com](mailto:quickdentalinternational@gmail.com)

[WWW.QUICKDENTALINTL.COM](http://WWW.QUICKDENTALINTL.COM)